

GERALD L. WENDT November, 1984
95 cents

QST

devoted entirely to

amateur radio

In this Issue—
**Practical
Communication
on 125
Centimeters**

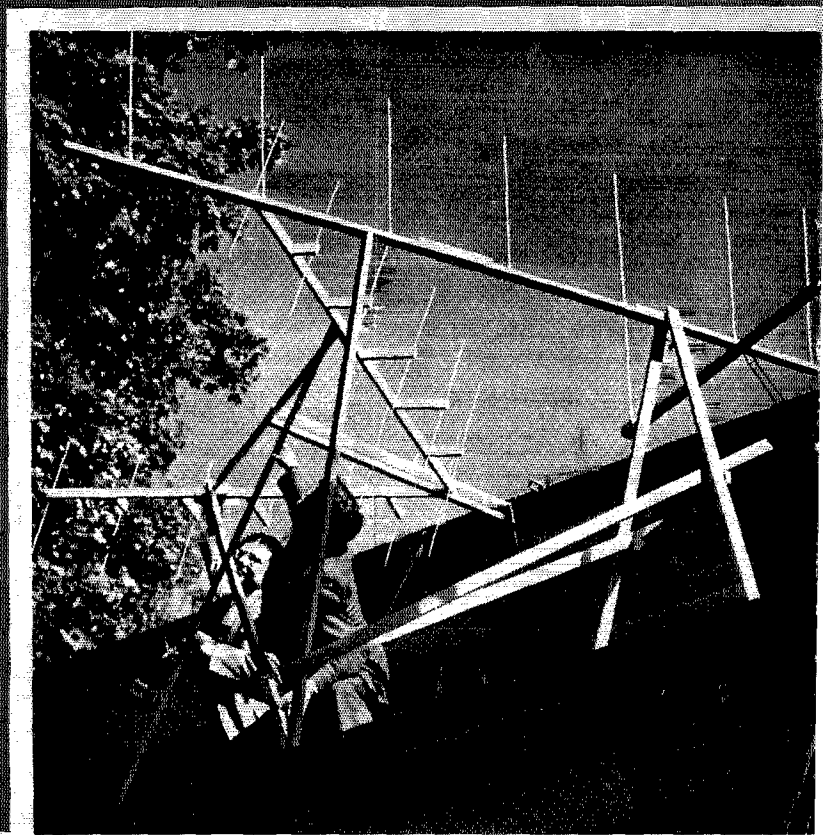

NOW . . .

COLLINS

30 FXB TRANSMITTER IN HANDSOME NEW CABINET

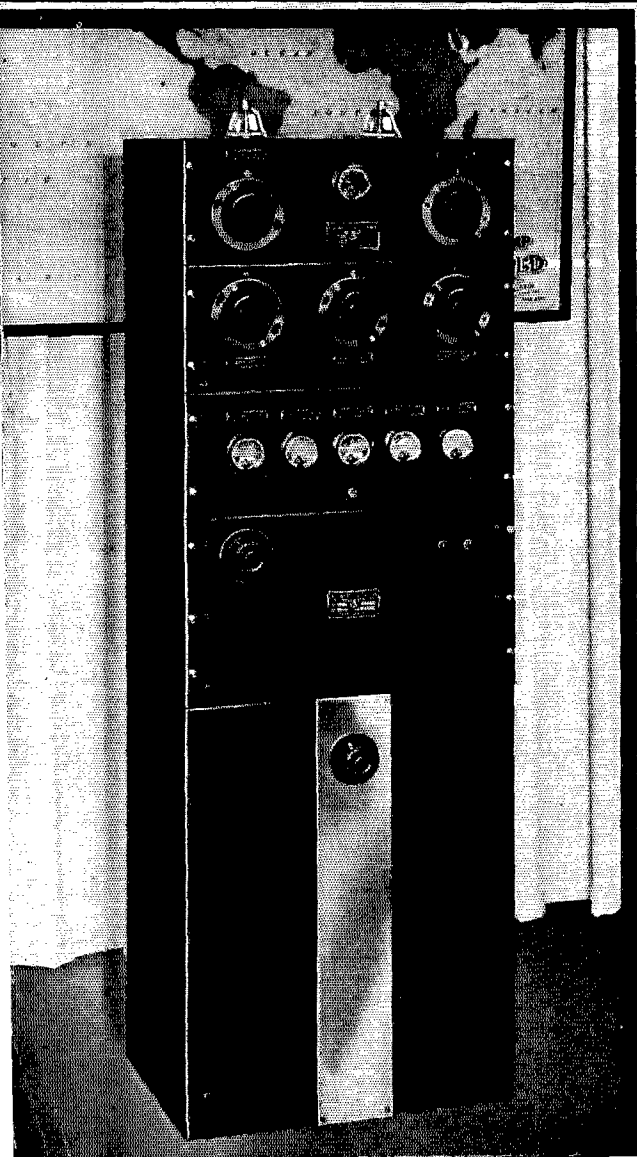

COLLINS RADIO COMPANY

CEDAR RAPIDS  IOWA, U. S. A.

New York Office—136 Liberty Street, N. Y.



FACTS ABOUT THE *Burgess No. 10 Unit Cell*

(Bureau of Standards Designation F)

Photograph shows Mr. E. J. Lybert, Burgess Sales Engineer, holding a No. TEN Unit Cell, the power unit of the batteries in the background.

The No. TEN Unit Cell

Has TEN ampere hours current capacity

Has TEN watt hours energy capacity

Costs TEN cents or less

It is the power unit in the Burgess Power House, the No. 1040 "A" Battery, which costs less than one cent per hour of service.

It is the power unit in the Burgess Heavy Duty "B" Battery, No. 10308, which is perhaps the best known battery in radio work.

It is the power unit in the Little Six—a full equivalent of the old-fashioned No. 6 cell.

It is the power unit in the No. 1022 flashlight battery, a two-cell battery for three-cell flashlights, and one which gives prolonged service.

You may rely on Burgess Batteries to incorporate the latest advances in battery manufacture. Burgess Laboratories are constantly searching for ways to improve the already superior performance of your black and white striped batteries. **BURGESS BATTERY COMPANY, FREEPORT, ILLINOIS.**

≡ BURGESS ≡

Say You Saw It in QST — It Identifies You and Helps QST

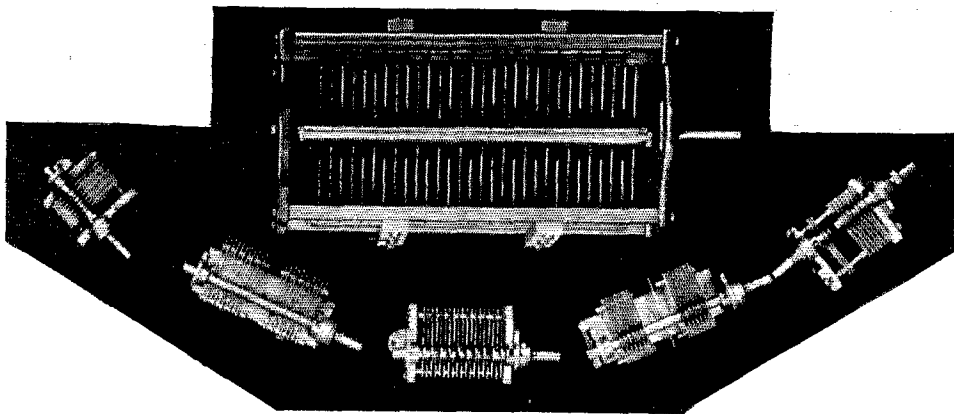

If it's a "HAMMARLUND" You KNOW It's GOOD!

ON THE question of mere *price*, Hammarlund occasionally loses a sale. But no one can afford to undersell Hammarlund **QUALITY!**

Nothing can ever be *too good* in radio. The problem, then, becomes one of selecting the best equipment you can buy for the price you can afford to pay.

If your need is for *dependable* Condensers, Chokes, I. F. Transformers, Coils, Coil Forms, Shields, Sockets, or a complete receiver or transmitter for which you will never have to apologize, we suggest that you consult the Hammarlund Catalog. And we are confident you will find the prices as low as for any similar products of equal quality. *Mail the Coupon NOW!*

LOW-LOSS, HIGH-EFFICIENCY COIL FORMS and COILS

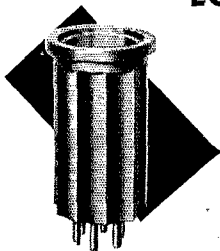

Recent development of the remarkable "XP-53" low-loss dielectric now makes it possible to offer highly efficient S-W Coils and Coil Forms at the lowest prices in Hammarlund history.

"IBT" MIDGET
TRIMMER CONDENSER



New types of compact Hammarlund Condensers now available for trimming, padding, and transformer-tuning. Some mount inside Coil Forms or Shields. They are accurately rated, constant and reliable under the most severe conditions.

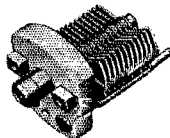

"APC"
AIR PADDING COND.



For Better Radio

Hammarlund

PRECISION
PRODUCTS

HAMMARLUND MANUFACTURING CO.
424-438 W. 33rd St., New York

- Check here and attach 10c for 16-page Hammarlund 1935 Short-Wave Manual, illustrating and describing most popular S-W circuits of past year, with schematic and picture diagrams and parts lists.
- Check here for FREE information on XP-53 Forms and Coils.
- Check here for FREE General Catalog.

Name.....

Address.....

Q-11

QST

Published monthly, as its official organ, by the American Radio Relay League, Inc., at West Hartford, Conn., U. S. A.; Official Organ of the International Amateur Radio Union

devoted entirely to

AMATEUR RADIO

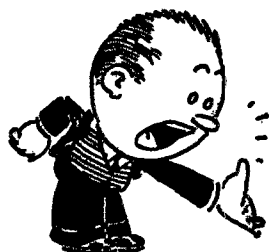

Editorials	7
Practical Communication on the 224-mc. Band Ross A. Hull	8
A Two-Way Telegraph and Telephone System for Code Practice Warren F. Jepson, W1NB and Fred B. Hoyle, Jr.	12
AT-Cut Crystals Available	12
High Power from the Crystal Oscillator Don Edmondo Ruspoli, 11MM	13
Detroit Police and Amateurs Coöperate for Emergencies Kenneth F. Conroy, W8DYH	17
Annual Sweepstakes Contest F. E. Handy	18
What the League Is Doing	20
The Directive Antenna at KA1NA D. C. Redgrave	21
High-Power 'Phone DeLuxe A. W. Anthony, Jr., W1CTE	24
Navy Day Receiving Competition	26
The Relay Rack in Amateur Construction G. Robert Mezger, W2BLL	27
The International Air Race	30
D. C. Measurements with the Ham Station Analyzer D. A. Griffin, W2AOE	31
With the Affiliated Clubs	33
Hamdom	34
Experimenters' Section	
BATTERY RECEIVER USING A TYPE 19 TUBE — POWER TRANSFORMERS IN SERIES — COUPLING A 57 S.A. TO A P.P. AMPLIFIER — SEPARATE REGENERATION IN MULTI-PURPOSE TUBE — DISABLING THE RECEIVER DURING TRANSMITTING PERIODS	35
Carrier Ratings with Suppressor-Grid Modulation	37
Station Descriptions W3KL, W5DLG, W3BWQ	38
I. A. R. U. News	40
Operating News	42
Correspondence Department	57
Silent Keys	70
The R-S-T System	72
Standard Frequency Transmissions	74
Book Reviews	76
New Transmitting By-pass Condensers	80
Hamads	90
QST's Index of Advertisers	94

NOVEMBER
1934

VOLUME XVIII
NUMBER 11

Kenneth B. Warner (Secretary, A.R.R.L.), Editor-in-Chief and Business Manager; Ross A. Hull, Associate Editor; James J. Lamb, Technical Editor; George Grammer, Assistant Technical Editor; Clark C. Rodimon, Managing Editor; David H. Houghton, Circulation Manager; F. Cheyney Beekley, Advertising Manager; Ursula M. Chamberlain, Assistant Advertising Manager.

Editorial and Advertising Offices
38 La Salle Road, West Hartford, Conn.

Subscription rate in United States and Possessions and Canada, \$2.50 per year, postpaid; all other countries, \$3.00 per year, postpaid. Single copies, 25 cents. Foreign remittances should be by international postal or express money order or bank draft negotiable in the U. S. and for an equivalent amount in U. S. funds.

Entered as second-class matter May 29, 1919, at the post office at Hartford, Connecticut, under the Act of March 3, 1879. Acceptance for mailing at special rate of postage provided for in section 1108, Act of October 3, 1917, authorized September 9, 1922. Additional entry at Concord, N. H., authorized February 21, 1929, under the Act of February 28, 1925.

Copyright 1934 by the American Radio Relay League, Inc.
Title registered at United States Patent Office.

BROADCASTERS GO *Sylvania*

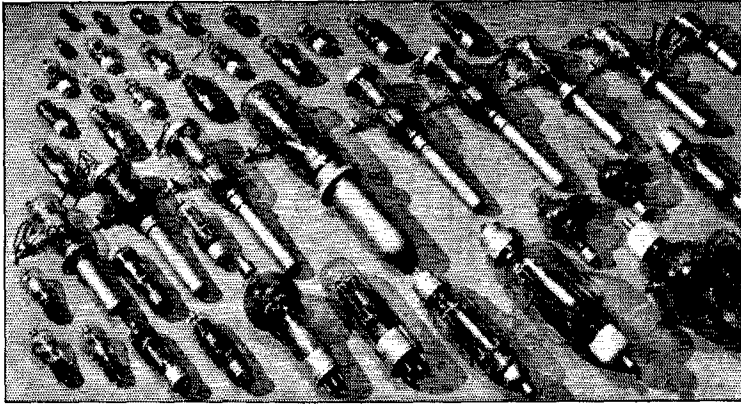

Sylvania HAS THE ONLY COMPLETE LINE OF GRAPHITE ANODE TRANSMITTING TUBES

Broadcast engineers are becoming more and more SYLVANIA-minded because they recognize the notably improved transmitting tubes which this company has developed and introduced. The progressive SYLVANIA achievements came after a long period during which no appreciable progress was made in power tube engineering. Leading scientists have proclaimed that the SYLVANIA Graphite Anode development marked the first fundamental improvement in transmitting tube design since the advent of broadcasting.

More than half of the broadcasting stations in the country are either partially or entirely SYLVANIA equipped. Engineers in steadily increasing numbers are specifying SYLVANIA. This is true not only in the broadcasting field but in all other fields of radio communication and for industrial application where dependable heavy duty service is demanded.

The SYLVANIA line spans the entire range of popular types in both air-cooled and water-cooled numbers.

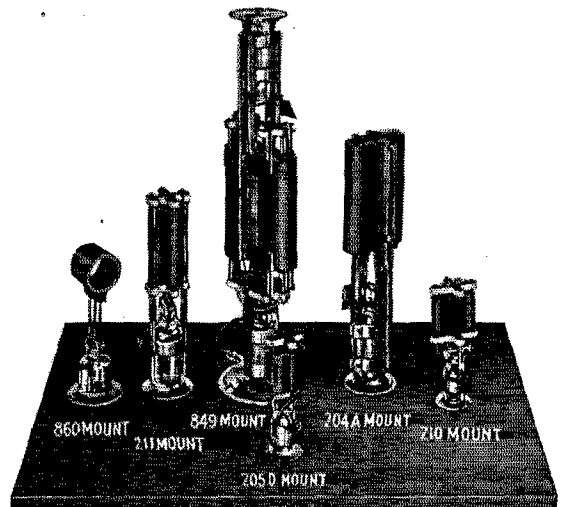

GRAPHITE ANODE MOUNTS

HYGRADE SYLVANIA CORPORATION

ELECTRONICS DEPARTMENT
AMATEUR RADIO DIVISION
CLIFTON, N. J.

FACTORIES:
SALEM, MASS.

EMPORIUM, PA. ST. MARY'S, PA.

CLIFTON, N. J.



Section Communications Managers of the A.R.R.L. Communications Department

All appointments in the League's field organization are made by the proper S.C.M., elected by members in each Section listed. Mail your S.C.M. (on the 16th of each month) a postal covering your radio activities for the previous 30 days. Tell him your DX, plans for experimenting, results in 'phone and traffic. He is interested, whether you are an A.R.R.L. member or get your QST at the newstands; he wants a report from every active ham. If interested and qualified for O.R.S., O.P.S. or other appointments he can tell you about them, too.

Eastern Pennsylvania Maryland-Delaware-District of Columbia Southern New Jersey Western New York Western Pennsylvania	W3GS W3BAK W3QI W8DSP W8UCG	ATLANTIC DIVISION Jack Wagenseller Edgar L. Hudson Gedney Rigor Don Farrell C. H. Grossarth	26 Meadowbrook Ave. 412 2nd Ave. 213 Hickok Ave. R. F. D. 3, Eicher Rd.	Llanerch Laurel, Delaware Haddon Heights Syracuse Emsworth, Bellevue Pa.
Illinois Indiana Kentucky Michigan Ohio Wisconsin*	W9WR W9TE W9ADH W8DVBH W8CIO W9ATO	CENTRAL DIVISION Fred J. Hinds Arthur L. Braun G. W. Mossbarger Kenneth F. Conroy Robert P. Irvine E. A. Cary	6618 West 34th St. 911 Relsner St. Box 177 7538 E. Robinwood Ave. 5508 Northcliffe Ave. 3642 N. 27 St.	Berwyn Indianapolis Camp Taylor Detroit Cleveland Milwaukee
North Dakota South Dakota Northern Minnesota Southern Minnesota	W9JVP W9PEFI W9JIE W9DEI	DAKOTA DIVISION Fred J. Wells Mike G. Strahon Robert C. Harshberger Francis C. Kramer	1022 11th St., S. 601 S. Grange Ave. 1200 Fauquier St. W. Bluff St.	Fargo Sioux Falls St. Paul St. Charles
Arkansas Louisiana Mississippi Tennessee	W5ARI W5DWW W5CWQ W4BBT	DELTA DIVISION H. E. Vette W. J. Wilkinson, Jr. J. H. Weems, Jr. Merrill B. Parker, Jr.	2918 West 15th St. 1624 Allen Ave. P. O. Box 244 1912 Oak St.	Little Rock Shreveport State College Chattanooga
Eastern New York N. Y. C. & Long Island Northern New Jersey	W2LU W2AZV W2EKM	HUDSON DIVISION Robert E. Haight E. L. Baunach John Rideg, Jr.	1080 Helderberg Ave. 7823 10th Ave. 20 Buena Vista Rd.	Schenectady Brooklyn Cedar Grove
Iowa Kansas Missouri Nebraska	W9LEZ W9FLG W9EYG-JPT W9FAM	MIDWEST DIVISION Phil D. Boardman O. J. Spetter C. R. Cannady Samuel C. Wallace	325 Kirkwood Blvd. 305 Western Ave. Broadway at Ninth Green St.	Davenport Topeka Monett Clarke
Connecticut Maine Eastern Massachusetts Western Massachusetts New Hampshire Rhode Island Vermont	W1CTI W1CDX W1ASI W1BVR W1APK W1QR W1ATF	NEW ENGLAND DIVISION Frederick Ellis, Jr. John W. Singleton Joseph A. Mullen Percy C. Noble Basil Cutting Albert J. King Harry Page	19 Merrill Rd. 10 High Street 16 Mercier Ave. 37 Broad St. 66 Lisbon St. R. 1	Norwalk Wilton Ashmont Westfield Pembroke Providence Hinesburg
Alaska Idaho Montana Oregon Washington	K7PQ W7AVP W7AAT W7AMF W7AYO	NORTHWESTERN DIVISION Richard J. Fox Don D. Oberbillig O. W. Viers Frank L. Black Stanley J. Belliveau	Box 301 P. O. Box 1271 211 Stevens St. 1502 McPherson St. Route 7, Box 387	Ketchikan Boise Missoula North Bend Yakima
Hawaii Nevada Los Angeles Santa Clara Valley East Bay San Francisco Sacramento Valley Arizona Flintstones San Diego San Joaquin Valley	K6EWO W6EAD W6BPU W6BMW W6ZX W6CAL W6DVE W6BJF-W6QC W6EAP W6EOP W6DZN	PACIFIC DIVISION Atlas O. Adams Keston L. Ramsay Howell C. Brown Charles J. Camp P. W. Dann Byron Goodman Geo. L. Woodington Ernest Mendoza Walter E. Thompson Harry A. Ambler G. H. Lavender	21st Infantry Brigade 1151 Buena Vista Ave. 120 N. El Molino Ave. 318 Hawthorne Ave. 1821 Chestnut St. 141 Alton Ave. 716 Redwood Ave. 1434 East Madison St. Boulevard Apartments 4101 Hamilton St. Route 6, Box 425	Schofield Barracks Reno Pasadena Palo Alto Berkeley San Francisco North Sacramento Phoenix Manila, P. I. San Diego Stockton
North Carolina Virginia West Virginia	W4AVT W3AAJ W8HD	ROANOKE DIVISION G. H. Wright, Jr. R. N. Eubank C. S. Hoffmann, Jr.	2817 Montrose Ave. 100 20th St.	Wendell Richmond Warwood, Wheeling
Colorado Utah-Wyoming	W9BTO W6GQC-IDM	ROCKY MOUNTAIN DIVISION T. R. Becker Arty W. Clark	1176 Gaylord St. 260 So. 9th West	Denver Salt Lake City, Utah
Alabama Eastern Florida Western Florida Georgia-So. Carolina-Cuba* Isle-of-Pines-Porto Rico- Virgin Islands	W4KP W4BCZ W4MS W4CE	SOUTHEASTERN DIVISION L. D. Elwell Phillip A. McMasters Edward J. Collins Bannie L. Stewart	1066 Waverly St. 212 9th St., North 1517 East Brainerd St. 310 Orange St.	Tarrant St. Petersburg Pensacola Georgetown, S. C.
Northern Texas Oklahoma Southern Texas New Mexico	W5AUL W5CEZ W5ADZ W5DUI	WEST GULF DIVISION Glen E. Talbutt Carter L. Simpson Bradfield A. Beard Dan W. De Lay	1133 Amarillo St. 2010 So. 4th St. 2030 Quenby Road 407 South Girard St.	Ablene Ponca City Houston Albuquerque
Maritime	VE1DQ	MARITIME DIVISION A. M. Crowell	69 Dublin St.	Halifax, N. S.
Ontario	VE3GT	ONTARIO DIVISION S. B. Trainer, Jr.	4 Shorncliffe Ave.	Toronto
Quebec	VE2GA	QUEBEC DIVISION J. A. Robertson	245 Edison Ave.	St. Lambert, P. Q.
Alberta British Columbia	VE4GD VE3AC	VANALTA DIVISION J. Smalley, Jr. R. K. Town	611 1st Ave., N. W. 1754 Graveley St.	Calgary Vancouver
Manitoba Saskatchewan	VE4GC VE4EL	PRAIRIE DIVISION Reg. Strong Wilfred Skafte	711 Ashburn St. 2040 McTavish St.	Winnipeg Regina

* Officials appointed to act until the membership of the Section choose permanent S.C.M.'s by nomination and election.

The American Radio Relay League



THE AMERICAN RADIO RELAY LEAGUE, INC., is a non-commercial association of radio amateurs, bonded for the promotion of interest in amateur radio communication and experimentation, for the relaying of messages by radio, for the advancement of the radio art and of the public welfare, for the representation of the radio amateur in legislative matters, and for the maintenance of fraternalism and a high standard of conduct.

It is an incorporated association without capital stock, chartered under the laws of Connecticut. Its affairs are governed by a Board of Directors, elected every two years by the general membership. The officers are elected or appointed by the Directors. The League is non-commercial and no one commercially engaged in the manufacture, sale or rental of radio apparatus is eligible to membership on its board.

"Of, by and for the amateur," it numbers within its ranks practically every worth-while amateur in the world and has a history of glorious achievement as the standard-bearer in amateur affairs.

Inquiries regarding membership are solicited. A bona fide interest in amateur radio is the only essential qualification; ownership of a transmitting station and knowledge of the code are not prerequisite. Correspondence should be addressed to the Secretary.

DIRECTORS

<i>President</i>	HIRAM PERCY MAXIM	W1AW
	Box 216, Hartford, Conn.	
<i>Vice-President</i>	CHARLES H. STEWART	W3ZS
	St. David's, Pa.	
<i>Canadian General Manager</i>	ALEX REID	VE2BE
	169 Logan Ave., St. Lambert, P. Q.	
<i>Atlantic Division</i>	EUGENE C. WOODRUFF	W8CMP
	234 W. Fairmount Ave., State College, Pa.	
<i>Central Division</i>	LOREN G. WINDOM	W8GZ-W8ZG
	Reynoldsburg, Ohio	
<i>Dakota Division</i>	CARL L. JABS	W9BVH
	1822 James St., St. Paul, Minn.	
<i>Delta Division</i>	M. M. HILL	W5EB
	P. O. Box 274, Natchitoches, La.	
<i>Hudson Division</i>	BERNARD J. FULD	W2BEG
	280 Broadway, New York City	
<i>Midwest Division</i>	H. W. KERR	W9DZW-W9GP
	Little Sioux, Iowa	
<i>New England Division</i>	G. W. BAILEY	W1KH
	74 Webster Road, Weston, Mass.	
<i>Northwestern Division</i>	RALPH J. GIBBONS	W7KV-W7BIX
	3134 N. E. 25th Ave., Portland, Ore.	
<i>Pacific Division</i>	S. G. CULVER	W6AN
	2962 Russell St., Berkeley, Calif.	
<i>Roanoke Division</i>	H. L. CAVENESS	W4DW
	State College Station, Raleigh, N. C.	
<i>Rocky Mountain Division</i>	RUSSELL J. ANDREWS	W9AAB
	1867 So. Lafayette St., Denver, Colo.	
<i>Southeastern Division</i>	J. C. HAGLER, JR.	W4SS
	2424 McDowell St., Augusta, Ga.	
<i>West Gulf Division</i>	FRANK M. CORLETT	W5ZC
	2515 Catherine St., Dallas, Tex.	

OFFICERS

<i>President</i>	HIRAM PERCY MAXIM, W1AW
	Hartford, Connecticut
<i>Vice-President</i>	CHARLES H. STEWART, W3ZS
	St. David's, Pennsylvania
<i>Secretary</i>	KENNETH B. WARNER, W1EH
	West Hartford, Connecticut
<i>Treasurer</i>	ARTHUR A. HEBERT, W1ES
	West Hartford, Connecticut
<i>Communications Mgr.</i>	F. EDWARD HANDY, W1BDI
	West Hartford, Connecticut
<i>General Counsel</i>	PAUL M. SEGAL, W3EEA
	1010 Shoreham Building, Washington, D. C.

Address all general correspondence to the executive headquarters at West Hartford, Connecticut



THE EDITOR'S MILL

THE general character of next year's board meeting will be decided to a certain extent by the petitions, letters and other expressions of opinion that each director will get from his constituents just before he leaves for West Hartford. But it will be decided to a far greater extent seven months before the board meeting by the action of the membership in its choice of representatives right now—election time.

Suppose you had two horses to choose from in a race. One hadn't done very much running this year, as yet, but is a thoroughbred and was a consistent winner last season. The other horse is a dilapidated tenth-rate plug which somebody bought cheap and tried to whip into winning form with two weeks of frenzied training just before the race. We don't know about you, but as far as we are concerned the plug wouldn't be worth even a thousand-to-one shot.

When it comes to directors it would similarly seem to be better judgment to make sure you have some real ability initially elected to the job, even if you never thereafter wrote him a line or petitioned him one little petish, than to elect any convenient Tom, Dick or Harry and then hope to get high-class results from him by deluging him with a mass of ideas, "whereases" and club votes just before he steps on the train headed east, next May.

That your directors actually do run the League is an oft-repeated but still not entirely recognized fact. Their power is unlimited. They elect the president and vice-president; they hire the treasurer, the secretary, the communications manager and the fieldman. They can fire them all at their will and appoint anybody they choose in their places. Theirs is the sole decision on matters of policy — regulatory, legislative, domestic and international. The League has a modest cash surplus which it has taken years of careful management to build up. When the board meets next May it can spend every cent of that surplus any way it chooses. At that meeting, if they wish, the directors can even order that the Handbook be abolished, or that *QST* have green covers, or that League dues be jacked up to \$50 a year. It's in their power to do it and your paid officers—who have no vote at board meetings, in case you don't know it—would have to do as directed.

During the next few weeks members in seven of the divisions of the League will have an opportunity to determine who shall represent them at that meeting next May. Half of the board's personnel is up for selection. The selection is yours, the individual member; the privilege of designating your representative is yours to exercise as you wish. You can send a nit-wit to the board if you want—and you have no kick coming if his decisions on important matters are nit-wit decisions. You can send Tom Jones because he's a good friend of yours and has a nice fist on the air, although you shouldn't expect him to perform miracles in crucial situations which your better judgment compels you to admit are probably a bit beyond his depth.

Or instead, bearing in mind the size, the importance and the prestige of amateur radio as it exists today, you can send as your representative a man of wide experience, a level head and mature judgment. Dozens of men with such qualifications exist in every League division, and the League and amateur radio need them badly—but the only way they can get on the board is for you, the members, to put them there.

—A. L. B.

Practical Communication on the 224-Mc. Band

The New Tube and Directive Antennas Reveal a World of Possibilities

By Ross A. Hull*

TWENTY-FOUR hours after we had obtained delivery of one of the new acorn type tubes, we had a duplex 35-mile communication circuit in operation using 56 mc. one way and 224 mc. the other. Directive antennas were used for both bands at the home station and plain antennas at the mobile station. Signals were maximum strength at both ends of the circuit. We thought we had had our full share of thrills

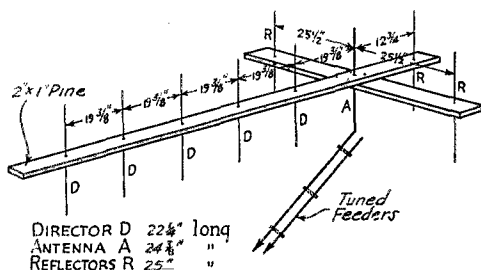

FIG. 1.—THE YAGI DIRECTIVE ANTENNA OPERATED AT WIAL ON 130 CENTIMETERS (ABOUT 230 MC.)

The antenna, director and reflector are made of 1/8-inch brass rod pushed through holes in the wooden structure, the latter being thoroughly soaked with hot paraffin. The feeders are cut approximately to an odd number of quarter wavelengths and tuned with series condensers in the conventional Zepp fashion. The supporting structure can be arranged in any one of a hundred ways—our next one will be on a rotatable pole hitched up to a brass wheel alongside the operating table!

during the recent work with directive antennas on 56 mc. But here was another one, fast on the heels of our recent fulsome dose. 224-mc. band signals that would just about burst the diaphragm of anybody's speaker—signals which appeared to have all the desirable characteristics of the 56-mc. ones (if not more).

During the few days since then we have built a couple of extra receivers and made a very sketchy preliminary survey of the manner in which a 130-centimeter wave from a directive antenna pokes its way through the Connecticut hills. The data at hand are far too meagre to allow any emphatic statement comparing 56 and 224 mc. but it is our impression that the signals on the new band soak into valleys and generally cover the landscape more effectively than our 56-mc. signals have done. At the moment we are

* Associate Editor, QST.

getting geared up for an attempt at contact between Hartford and Boston on 130 centimeters and enthusiasm in these parts is running very high. The reception of strong signals in an automobile over a 50-mile path blocked by hills 1200 feet high leads us to suspect very strongly that all sorts of surprising distances will be possible just as soon as we fit out the necessary directive antennas for reception and transmission at both ends of the circuit.

The tremendous advantage of operation on the extremely high frequencies is not in the novelty of the work but in the possibility of fitting out a highly effective directive antenna while still keeping it small enough to pick up and cart around. It takes a fair amount of space to fit out an antenna with a power gain of twenty on 56 mc. but there is no conceivable location in which there would not be room for a dozen such antenna systems suited for the 224-mc. band. The "signal squirter" with a brass wheel controlling its direc-

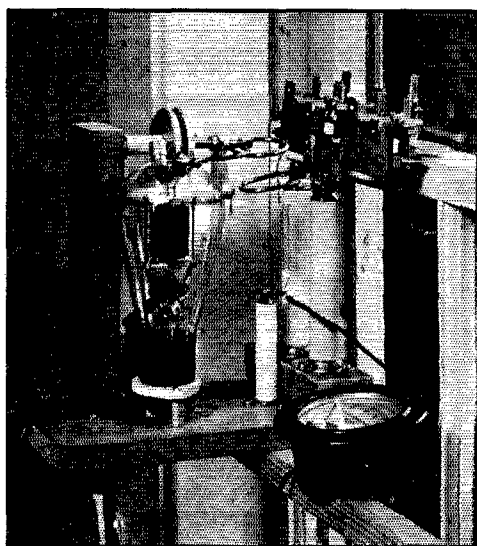

FIG. 2.—THE LIGHT IN THE WINDOW—THE 130 CENTIMETER TRANSMITTER AT WIAL

Mounted right in the window frame, this simple transmitter pushes large chunks of juice to the directive antenna on the veranda roof. The antenna, in turn, squirts this at the moment, in a northeasterly direction.

tion alongside the ham operating position is no dream of the distant future. If we can afford the brass wheel we will build one just as soon as we finish writing this article.

Before describing the equipment which has worked out so nicely in our case, we might mention the considerations involved in deciding upon 224 mc. as the band on which to start this ultra-ultra-high-frequency work. The acorn tube is thoroughly satisfactory for operation down to about half a meter. In other words, there would be no serious tube problem in reception on any of the wavelengths under consideration. Operation at wavelengths below about 125 centimeters, however, would mean that the only available tube for transmission (using conventional circuits) would be the "acorn." Since we wanted to be able to use higher powered transmitters than would be provided by the new tube, we decided that the band from 224 to 240 mc. (about 134 to 125 centimeters) would be the ideal spot. The W.E. 304A or the 800 are capable of splendid operation in that territory and provide all the steam one would want.¹ The 224-mc. band was selected in preference to the 112-mc. band for the very simple reason that the directive antenna could then be kept down to the point where even

¹Other circuit and tube combinations were discussed in "Firing Up on the Newly-Opened Ultra-High Frequencies," *QST*, September, 1934.

a highly directive system would be small enough to fit in any attic or on any porch roof.

The antenna chosen for our first work is of the "Yagi" type. In this system, a single half-wave antenna is used, backed by one or more reflectors and fitted with a series of directors strung out in

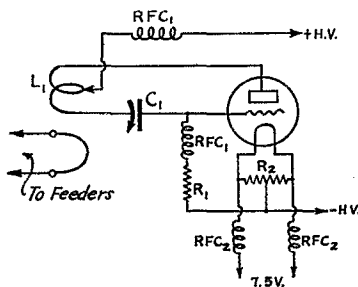

FIG. 3—CIRCUIT OF THE 130-CENTIMETER (224-MC. BAND) TRANSMITTER

- C₁—National Type NC800 condenser.
 - L₁—Single turn tank coil of very small copper tubing or No. 12 gauge wire. Actual length of conductor is 7 inches—the turn 1-inch diameter.
 - R₁—20,000 10-watt resistor.
 - R₂—50- or 100-ohm center-tapped resistor.
 - RFC₁—15 turns of No. 18 wire wound on a pencil—the turns being pulled apart slightly.
 - RFC₂—About 10 turns of the filament leads wound on a pencil (see Fig. 2).
- The new W.E. 304A is now used in this circuit at AL. The 800 shown in Fig. 2 was also satisfactory.

Five-Meter Performance Hits New Levels

Directive Antennas Permit Smashing All Records:
Activities at High Pitch

WAS it freaky weather, never to be duplicated? Was the location just one in a million? Has anyone else been able to duplicate it?—These were the questions aired freely when Ross Hull revealed the amazing effectiveness of the directive antenna he had strung up at W1AL. Months of continuous communication, observation, and comparison are needed before the final answers can be made, but at this stage it certainly looks as though we can rule out all thoughts of freakiness. With Headquarters ops taking shifts, AL has been kept on the air every night (six weeks of it at this writing) and for schedules each morning. Ninety-seven out of an even hundred schedules with W1HRX have resulted in satisfactory communication. Every day since October *QST* went to press with Hull's story, Hartford-Boston contact has been had. Signals are, of course, not always the same strength. Dizzy cycles of good and bad weather follow each other at intervals of a few days with steady R9 signals one night and severe fading the next. But communication holds up just the same.

And that isn't all! AL was heard strongly by

Mr. H. S. Shaw, of General Radio, 292 miles along the line of the beam at Mt. Desert Island, Me. Wow! Then, a four-hour continuous contact was had with W1XR at Mt. Washington (190 miles) using a second antenna pointed in that direction. Many excellent contacts have been had with Dr. G. W. Pickard, W1XZ, at Seabrook, N. H. (127 miles, with XZ located on the beach within a stone's-throw of the sea) and as many as 13 consecutive QSO's with Boston area hams have been had after a single CQ.

In short, an ultra-high frequency directive antenna does things!

The response to Hull's article has been perfectly swell. We gain the impression, from telegrams, radiograms and letters, that directive antennas are sprouting like mushrooms over the whole countryside. The first new one heard at AL was W1ZO at Medford, Mass. With a 200-volt plate supply, ZO handed us an R9 signal if ever there was one.

Watch the coming issues of *QST* for further dope on directive systems and for reports of the experiences at other stations.

—EDITOR

front of the antenna along the line of transmission. The antenna has the merits of being very simple to construct and infinitely simpler to adjust than any system in which several antennas have to be

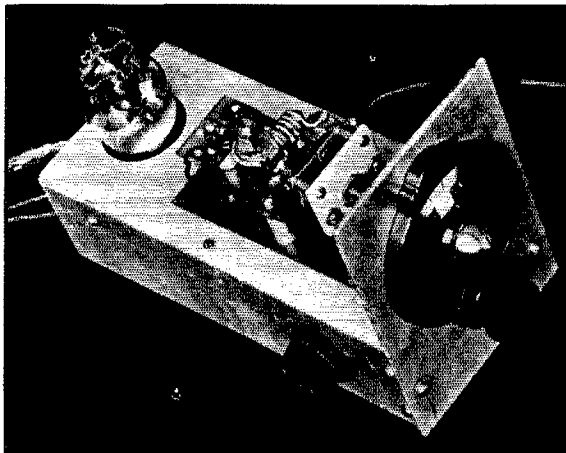

FIG. 4—THE LAST OF THREE 224-MC. BAND RECEIVERS

Though having the appearance of a permanent assembly, this receiver is nevertheless capable of easy modification. The detector equipment is mounted on its own small copper plate base and can be removed as a unit in quick time. The audio tube is "sunk-mounted" in order to conserve panel height

fed in phase or with some particular phase relationship. Fig. 1 gives full details of the antenna and the wooden frame upon which its elements were mounted. In the installation at W1AL this frame was in turn supported on a tripod arrangement made of 2" x 1" pieces. The wooden elements through which the antennas, directors, and reflectors were pushed, were well painted with hot paraffin.

TRANSMITTER

The transmitter used at AL employs the circuit given in Fig. 3. This is just about the simplest circuit one could imagine but, with a 304A or 800 tube, proved capable of delivering substantial power—enough, at least, to permit checking the operation of the antenna with a neon bulb. The input power was held down to about 40 watts (70 ma. at something under 600 volts). The transmitter was set on the desired frequency first by making a check with a Lecher wire system (to be described) and then by listening to the signal in a 56-mc. receiver. With the transmitter set on 130 centimeters, a harmonic of the 5-meter receiver provided a signal at approximately 57 mc. The Zepp feeders were then cut to approximately an odd number of quarter waves, hitched to the antenna of the Yagi system and tuned with the conventional series condensers at the station end. These condensers happened to be Cardwell neutralizing condensers. Any two or three-plate midgets would serve the purpose.

CHECKING FREQUENCY

Since some difficulties have been reported by ultra-high frequency enthusiasts using the Lecher wire arrangement for checking wavelength we will describe the actual layout used in our work. The wires themselves are of No. 18 bare copper wire strung two inches apart between stand-off insulators along an eight-foot length of board. One end of the wires remains free, the other ends being connected to a one-turn coupling coil located near the transmitter tank circuit. In operation, a sliding bridge—consisting of a piece of stiff bare wire on the end of a two-foot wooden dowel—is run slowly down the length of the wires until a point is reached where the oscillator plate current makes a sudden fluctuation. The point is marked. The bridge is then moved farther down the wires until a second node is located. This also is marked. The same procedure is then followed to locate a third node. At this stage, the distance between each pair of marks is measured. If the Lecher system is operating correctly and if it is mounted well clear of surrounding objects, the distances will all be the same and will represent quite accurately one half of the wavelength being measured. An alternative sliding bridge—useful when the oscillator has plenty of output—is a flashlamp bulb with wires soldered to its contacts. These wires are hooked over the wires of the Lecher system and the lamp

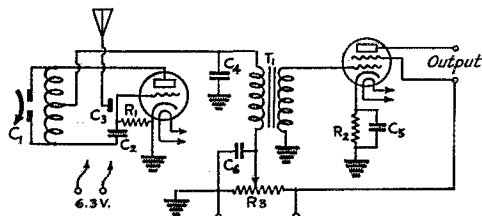

FIG. 5—CIRCUIT OF THE SIMPLE 224-MC. BAND RECEIVER

C₁—Special split-stator tuning condenser (see text). Since the photographs were taken it has been found desirable to use two pairs of stator plates instead of one in order to give ample extra frequency coverage.

C₂—Very small grid condenser (see text).

C₃—Brass strip 3/16 inch wide mounted close to the exposed surface of C₂ (see Fig. 6).

C₄—.002 μfd. fixed condenser.

C₅—2 μfd. or more.

C₆—1 μfd.

R₁—1.5 megohm, half-watt resistor.

R₂—1200 ohm, one-watt resistor.

R₃—100,000 ohm potentiometer. Note that this resistor is across plate supply and that, if batteries are used, the supply should therefore be disconnected when switching off set.

A 41 tube is used as the audio amplifier and allows speaker operation. A transformer or choke-condenser coupling unit must be used with this tube. For headphonework, a 37 audio tube would probably be more appropriate.

The coil is described in the text.

moved along until the various points are located at which the lamp lights brightest. The points will be extremely critical.

RECEIVERS

Three different receivers have been built for this experimental work during the last three days. The gadget illustrated in Figs. 4, 5 and 6 is No. 3 of the series. Its circuit arrangement, shown in Fig. 5, is the simplest of the lot. In operation, the set is just about as smooth as one could imagine. The first of our receivers was an elaborate affair in which the most profound precautions were taken in the layout of the detector circuit, in the provision of by-passing and in the fitting of some means of adjustment for almost everything in the circuit. Our experience with this receiver and with No. 2 of the series served to reveal many of the beautiful features of the new tube. We were afraid of it at first but we soon learned that, given half a chance, the tube will perform on, say, 130 centimeters, in just about the way one would expect a 37 to handle on 75 meters.

The key unit in the new receiver is the detector assembly. It is built on a heavy copper plate, measuring two inches by four inches. The assembly includes the tube socket and the tuned circuit components and therefore constitutes a complete oscillator which could be fitted into almost any type of receiver or low-

powered transmitter. In this particular instance, we attached the copper plate to the channel of a receiver chassis, hitched a pentode audio amplifier and—presto—acquired a complete super-regenerative receiver. The detector is, of course, of the self-quenching type. A separate interruption oscillator was used in the first two receivers but, for reasons yet to be discovered, it did not seem to justify its existence.

Since the most important part of the receiver is the input to the detector, we will discuss it in some detail. The tube socket is made from two strips of "Victron." These could be obtained from a sheet of the raw material or cut from a National Victron transposition insulator. Any other high-grade insulating material could, of course, be used. These two strips, fitted with the lugs that come with the tube, are supported slightly above the copper base in order to avoid the necessity for drilling the copper to accommodate the bottom of the tube. Our first receiver had a hole cut in the copper plate in the manner suggested in the instruction sheet for the 955. We deviated from that procedure in this case with the idea of

avoiding structural complications. Since the smallest midget condenser did not appear to be satisfactory for the grid condenser C_2 , we proceeded to build one from two pieces of brass, measuring $\frac{3}{4}$ by $\frac{3}{8}$ inch. Each piece was folded in two and the pieces were then interleaved, the plates being kept apart by thin pieces of mica. The whole assembly was drenched with Duco cement and then squeezed in a vice. A lead was then soldered to each of the brass elements. Another item which had to be "homebrewed" was the tuning condenser. Believing that the normal midget condenser has an excessively large path between its terminals, we cooked up a special condenser shown clearly in Fig. 6. It consists of a three-plate Cardwell Trim-air midget with the one stator plate sawn down the middle. In this way a split stator condenser is obtained—one having an extremely low minimum capacity and a short path between one terminal and the other. It

(Continued on page 68)

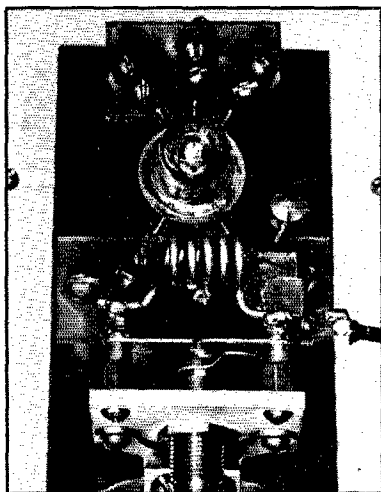

FIG. 6—THE "ACORN" DETECTOR TUBE AND ITS TUNING EQUIPMENT

The tuning condenser shown with two rotor plates and one pair of stator plates (a single stator plate split) has since been provided with another pair of stators to give ample tuning range on either side of the 224-mc. band. The grid condenser may be seen immediately to the right of the coil. The brass strip of the antenna coupling condenser can be seen apparently touching the right-hand coil connection.

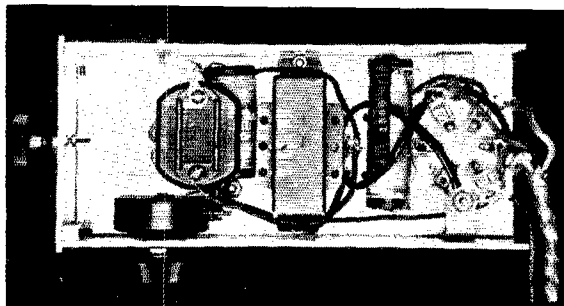

FIG. 7—UNDERNEATH THE 224-MC. BAND RECEIVER

All the gadgets not above the chassis channel can be spotted in this photograph. The location of the detector voltage control potentiometer is perhaps unconventional but certainly convenient in operation.

A Two-Way Telegraph and Telephone System for Code Practice

By Warren F. Jepson, WINB, and Fred B. Hoyle, Jr.*

FOR code practice between two operators and for intercommunication between two houses the following system was devised. It is believed that some of its features will prove interesting to others.

Each "station" consists of an audio-frequency oscillator following the description given in the *Handbook*. (See p. 10, Eleventh Edition.) The first step is to obtain two audio transformers with good windings. A transformer which gives a high-pitched, musical note is to be preferred to one with a low-pitched note. The old uncased type General Radio Company audio transformer pro-

found in the incorporated "voice-power" telephone system. So long as the key (KS) at A is closed, the operators can telephone, quite satisfactorily amid quiet surroundings, by talking aloud with the phones on their heads (this mystifies the uninitiated!), and can secure even better results by talking into one phone and listening with the other. This feature enables an immediate check to be made on code and also provides a useful interphone. The battery is not essential to the operation as a telephone. The line between stations here is about 150 feet long, but a much longer line should prove practicable. Good phones of approximately equal impedance per pair should be used for best results.

Lead-covered cable was available and was used for the outdoor portion of the line. An open-wire line or twisted pair should work as well, or a single wire with ground return might be tried.

Failure of the oscillators to "perk" may be due to a reversed transformer winding or to reversed polarity of the line at Station B.

There are many other uses for such an intercommunication system. The output of a receiver may be put on the line for the other listener's benefit. This is one way of monitoring your transmitter at a distance. The outfit should make an ideal Boy Scout communication

system. But we'll let you think up the other applications.

AT-Cut Crystals Available

THE crystal manufacturers have been busy since the announcement of the new Bell Labs AT crystal cut, recorded in October *QST*, and it is expected that by the time this issue is in print crystals will be commercially available. Besides having a very low-frequency temperature coefficient, the new cut reduces the tendency of the crystal to vibrate in unwanted modes to such an extent that the crystals are even more active than the Y cut. For the same reason the AT-cut crystals are less likely to crack under abnormal vibration amplitudes. Probably most amateurs will consider these characteristics of even more importance than the elimination of "creeping."

(Continued on page 78)

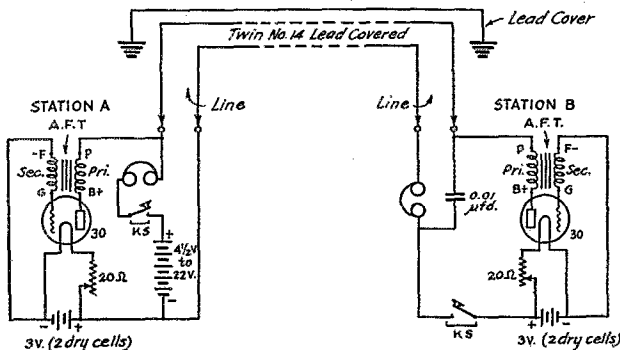

FIG. 1—CIRCUIT OF THE TWO-WAY CODE-PRACTICE SYSTEM

KS of Station A is closed for receiving, stand-by and voice. Station A's oscillator need be used only for calling Station B, and then turned off. KS of Station B is closed for receiving, open or closed for stand-by and voice. Station B's oscillator is used for calling Station A and by both stations for operating break-in.

duces a very powerful and pleasing note. A suitable note can be heard 30 feet or more from the phones which obviates auxiliary calling apparatus.

The all-important fixed condenser may have a value between 0.005 and 0.05 μ fd. Larger condensers cause the code to lag and become blurred. While the Type 99 or 30 tubes are very suitable in this outfit, other triodes should prove satisfactory. The circuit diagram should be self-explanatory.

The way we prefer to operate the "break-in" system is as follows. Oscillator B is keyed by one operator while the other man keeps his key closed. The latter can "break in" by opening his key. Upon hearing no signal in his phones the sending operator closes his key and waits for the interruption.

A rather unusual and very useful feature is

* 50 Highview Ave., Melrose, Mass.

High Power from the Crystal Oscillator

A Controlled-Oscillator Circuit in Which Crystal Load Is Adjustable

By Don Edmondo Ruspoli*

THE foremost limitation of the crystal-controlled oscillator lies in its lack of power. Many readers of *QST* have applied a few watts to the plate of one of these oscillators, only to find they had gone just too far and ruined an expensive quartz plate. If one could only apply 100 or 150 watts to the plate of a power tube, *crystal controlled*, and key the tube, getting clean-cut stable signals, what a saving of complication and expense!

We wonder how many crystal users have actually measured the radio-frequency current flowing through their quartz plates. It is quite easy to connect a thermo-couple galvanometer or milliammeter in series. The author uses a Weston Model 425 or 507, 0-250 ma. instrument. The readings on this meter will furnish some information as to the strain during operation. As an example, a UV-211 tube operating as a standard c.c. oscillator and feeding into a 40-meter Zepp, will give, with a plate power of 15 watts (300 volts, 50 ma.), a current in the crystal meter of over 200 ma. r.f. This current should not be exceeded if the crystal is to be kept in order.¹

Using crystal control modified as will be later explained, the author has applied as much as 200 watts to the plate, using a 40-meter crystal, the note given by the monitor staying constant while knocking the transmitter or shaking the feeders. The crystal meter registered only 75 milliamperes. But before going into circuit details, let us turn to some theoretical points concerning vacuum-tube oscillators.

* IIMM, 19, Avenue Rapp, Paris, VII, France.

¹ Many amateurs consider a crystal current of 100 milliamperes to be the safe limit of a 3500-kc. crystal, with corresponding reductions for higher-frequency crystals.—Editor.

GRID-CIRCUIT DEVICES

In an oscillator, retroactive coupling from the plate to the grid circuits is provided inductively or electrostatically. With high frequencies, and with tubes such as the UV-211, for example, the capacities between electrodes may suffice for feedback; with other types supplementary coupling may be necessary for oscillation to be possible. In the discussion that follows it will be assumed, for the sake of having a concrete example, that we are dealing with the above-mentioned UV-211 tube. Proper allowances will have to be made, of course, when departing from these conditions.

When oscillating voltages appear at the plate, potential impulses are imparted to the grid through the tube capacity, and an r.f. grid voltage builds up, provided proper conditions exist in the grid circuit. We know, for instance, that if grid and filament are united through a system equivalent to a pure resistance grid voltage can not build up, and oscillation is impossible (Fig. 1A).

Between grid and filament must be connected a device possessing characteristics of resonance, combined with proper impedance at the frequency of the plate oscillations. A tuned LC circuit, Fig. 1B, or a piezoelectric crystal, Fig. 1C, possess these attributes, and may be used in the grid circuit. The t.p.t.g., or the standard c.c. oscillators are then obtained.

We furthermore know that the grid circuit, while required to be responsive, must not be too much so, since excessive grid excitation leads to poor efficiency.

The responsiveness, or the impedance, of the grid circuit must be carefully and exactly adjusted for given conditions of plate characteristics, load, frequency, etc.

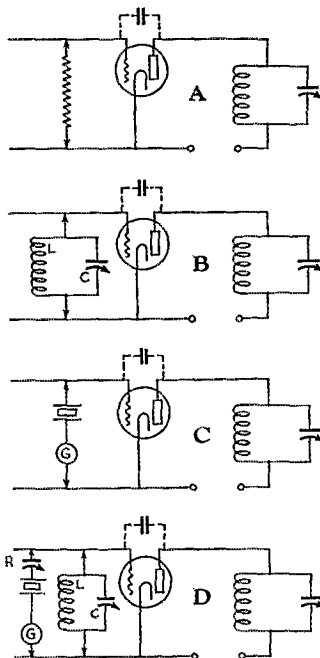

FIG. 1—CHARACTERISTICS OF GRID-CIRCUIT DEVICES

- A—Pure Resistance
No oscillation possible.
- B—LC Circuit
Oscillation possible. Excitation usually adjusted by detuning the LC circuit. Plate tuning sets frequency.
- C—Crystal
Oscillation possible. Excitation usually adjusted by detuning plate circuit. Large current in crystal meter.
- D—"R" Circuit
Oscillation possible. Crystal governs frequency. Excitation adjusted by condenser R, LC circuit and plate tuning. Low current in crystal meter.

The above-mentioned resonant devices may be regarded as sources of grid excitation which they can deliver in varying quantity according to adjustments. Arbitrarily representing correct



THIS TRANSMITTER, USING THE CIRCUIT OF FIG. 3 WITH THE ADDITION OF A PLUG-AND-JACK ARRANGEMENT TO COMPARE DIFFERENT TYPES OF GRID EXCITATION, DELIVERS OUTPUTS UP TO 100 WATTS ON 7-MC. FROM A UV-211 CRYSTAL OSCILLATOR

excitation as to 100 units, let us examine, from this standpoint, a few particular cases.

ADJUSTING EXCITATION

If we take a t.p.t.g. oscillator, Fig. 1B, with a light load coupled to the output circuit, and tune the grid circuit *exactly* to the plate frequency, we will certainly produce excessive grid excitation. The grid circuit will be too responsive and will deliver perhaps 200 units. We will have to reduce its response to 100 units in some way. In practice, we generally detune it. This is a convenient method, but different means might be used, such as introducing resistance, altering the LC ratio, tapping the inductance coil, etc.

If we handle a standard c.c. oscillator, Fig. 1C, similarly, we find that if during oscillation the plate circuit is brought near to tune with the crystal, excessive grid excitation is generally brought about with poor efficiency and increased strain on the crystal. Here again our grid device (the crystal) may possibly be delivering 200 units. Again, the grid response must be reduced to 100 units, and as before a choice of methods is available. Resistance can be introduced into the circuit, the plate can be detuned, the load can be increased, the plate voltage cut down, or capacity can be introduced in series with the crystal to drop the voltage applied to it. Usually the plate detuning is the most convenient

method, but the others might be used for special purposes.

Suppose that a combination of t.p.t.g. and c.c. is used, as illustrated in Fig. 1D. Both LC circuits are tuned close to the crystal frequency. Here again we notice that the grid excitation is far too high; it may have reached perhaps 300 to 400 units. How shall we cut it down? The methods above can be resorted to but we must remember that the grid response derives from two sources, the LC circuit and the quartz plate. If we weaken the response from the crystal only, by introducing a small condenser in series, and cutting the capacity down to practically zero, we simply return to the t.p.t.g. oscillator. Grid response will still be too high and will have to be reduced, as previously explained, down to 100.

If we introduce impedance into the LC branch of the grid network, leaving the crystal branch undisturbed, and then annihilate the effect of the tuned grid circuit altogether, we will be left with a standard c.c. oscillator. As before, it will have to be specially treated if excitation is to be brought down to 100.

THE "R" CIRCUIT

But we may proceed in yet another manner which will constitute a somewhat novel feature in our adjustments.²

Both sources of excitation can be weakened at the same time, and to varying degrees, in such a manner that their combined delivery of excitation will equal 100.

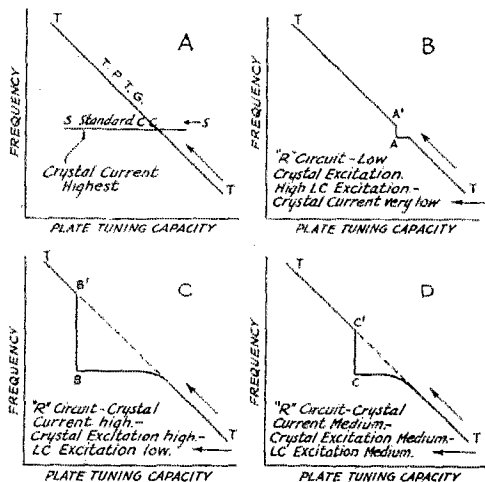

FIG. 2—TUNING CHARACTERISTICS OF T.P.T.G. ORDINARY CRYSTAL CONTROL, AND "R" CIRCUITS, THE LATTER WITH VARIOUS RATIOS OF CRYSTAL TO LC EXCITATION

As an illustration, we may imagine the crystal to be adjusted at 10, with the LC at 90, or vice

² U. S. Patent 1,956,134.

versa, or crystal at 25 and LC at 75, or again both at 50. We can theoretically obtain a continuous range of adjustments, all giving the correct degree of excitation, from standard c.c. to t.p.t.g. through an infinity of intermediate combinations. The practical advantage to be found in these intermediate adjustments will be explained.

Adjustments being subdivided as shown, into three classes—t.p.t.g., standard c.c., and intermediate or Class “R”—we will now consider the question of frequency stability.

STABILITY RANGES

In Fig. 2 we have plotted plate-capacity tuning versus frequency, and we propose to examine curves obtained with the three classes of adjustments while decreasing the capacity from large towards small values, leaving grid arrangements unvaried throughout the plotting of each curve. Grid excitation will of course be affected by plate tuning, if corresponding grid circuit readjustments are not brought about. But the curves are not working curves; they are merely intended to show frequency phenomena.

With the t.p.t.g. we get a curve $T-T$, showing continuously increasing frequency with decreasing capacity, Fig. 2A.

With standard c.c., the curve is a practically horizontal line $S-S$, indicating that frequencies are almost unaffected by capacity changes within the limits of oscillation.

With an “R” circuit the frequency follows the t.p.t.g. law for a certain range of capacities, then bends toward the c.c. curve, following it almost horizontally until a point A, B or C (Fig. 2B, C, D) is reached, when stabilization suddenly ceases and the curve ascends vertically back to the t.p.t.g. characteristic, which it follows from there on.

Whether the vertical jump is taken at A, B or C, and whether the horizontal portion of the “R” curve is narrow or broad, depends on the proportion of LC and crystal excitation, as defined previously.

On all adjustments corresponding to the horizontal portion, stability is practically equal to that obtained with the standard crystal oscillator, and detuning influences such as antenna swinging or vibrations of the set itself will not interfere with the frequency, provided of course that these causes do not carry the working point of the curve beyond its horizontal limits.

POWER DISSIPATED IN GRID CIRCUIT

We will now consider the power dissipated in the grid circuit, which we will suppose to be 10% of the plate power at the correct excitation adjustment.

In the R circuit this power will be divided between the devices furnishing the excitation. The device furnishing the most excitation will dissipate the most power. By reducing the crystal percentage of excitation we also reduce the power

used up in the crystal, and at the same time the strain it undergoes and its liability to get broken. This relieved strain will not prevent proper frequency stabilization so long as the flat portion of the curve is not overstepped.

If we can allow the crystal to consume one watt safely, our plate power limit with standard c.c. would be 10 watts. With an R circuit at a 10 crystal and 90 LC adjustment, the power dissipated in the crystal would only be one tenth of a watt, or 1% of the plate input, and we might increase the latter to 100 watts before

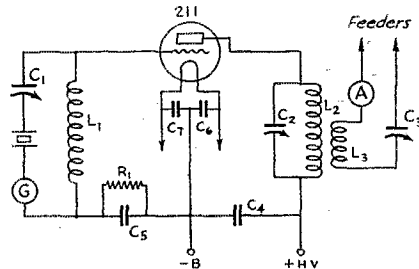

FIG. 3—A PRACTICAL CIRCUIT FOR OPERATING A 7-MC. CRYSTAL OSCILLATOR AT INPUTS OF 100 WATTS OR MORE

Adjustments should be made as described in the text. Circuit constants are as follows:

C_1 —Small variable condenser; should have capacity approximately the same as that of the crystal holder. A three-plate midjet is suggested.

C_2, C_3 —500- μ fd. variable.

C_4, C_5 —.002 μ d.

C_6, C_7 —.002 μ d. or larger.

R_1 —2000 ohms.

L_1 —9 turns No. 28 s.c.c. wire on 1-inch form. Turn spacing adjusted as described in text.

L_2 —6 turns $\frac{1}{4}$ -inch copper tubing, diameter of coil 2 $\frac{1}{4}$ inches.

L_3 —5 turns same as L_2 .

G —Thermo-milliammeter, 0–250 ma.

A —Antenna ammeter, 0–3 amp.

reaching the safety limit of the quartz. Naturally, we are assuming that a 10% basis of crystal action is sufficient in practice to insure stability without accidental causes running the working point over the limits of the flat portion of the curve. My experience is that a 10 basis is satisfactory. In fact, smaller percentages can often be used, as most accidental detuning causes produce relatively small displacements on the curve, so that a fairly narrow horizontal portion is quite permissible.

By this means we attain the result of using much higher power on a transmitter stabilized by a quartz crystal than is usually the case, and an outfit handling 100 watts or so need not comprise two stages.

CONSTRUCTION AND ADJUSTMENT

The set illustrated by the photographs and by the diagram, Fig. 3, was built by the author for demonstration purposes and airplane experiments. Plug and socket arrangements were provided on the front of the panel for changing

quickly from one type of circuit to another. This feature, not shown in the diagram, can be dispensed with, thus simplifying the construction. The general type of assembly and layout of parts is recommended, although according to individual requirements a few changes will probably be desired.

The important adjustment is that of grid excitation. Experience points to the following as a good method of procedure.

A good 40-meter crystal must be selected, since a poor one is apt to have secondary frequencies close to the principal frequency, and jumping

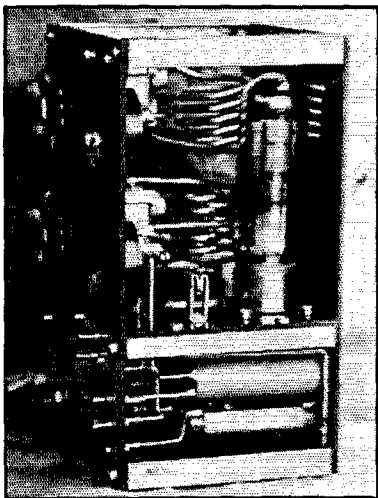

THIS SIDE VIEW OF THE TRANSMITTER SHOWS THE TANK AND ANTENNA CIRCUITS, TUBE AND CRYSTAL HOLDER

The plate tank circuit is high-C as in ordinary self-controlled oscillators.

from one to the other may occur during operation.

The monitor must be set to the exact frequency of the crystal, and the condenser R then turned to zero, suppressing crystal action altogether. The grid inductance is then tackled; 9 turns of the fine wire on a one-inch diameter form may be tried. No variable condenser is used in this case to tune the grid LC circuit, as it is assumed that the choice of grid turns will cause them to be satisfactorily tuned by the stray capacities present.³ The LC circuit will not tune sharply, but we do not want it to. The turns will very likely need a little adjustment in spacing. The coil I used was wound with turns close, and 4 turns were finally pushed about 1/16th of an inch away from the remaining ones. Detuning the antenna so as to slacken the load slightly, the coil will be about right if it will just make the set oscillate as a t.p.t.g. at the crystal frequency. (The monitor,

³ The similarity to the process of adjusting the TNT grid coil will be recognized.—EDITOR.

as we have said, must give us this frequency.) It is supposed that at full load, the oscillator would just fail to oscillate as a t.p.t.g.

Oscillation is next stopped by giving the plate condenser a large capacity, and the condenser R is set to a trial value perhaps $\frac{1}{2}$ of its total capacity. The plate condenser capacity is then decreased slowly. While approaching tune the grid meter will show a reading, which will increase until a certain point when it will suddenly fall to zero. The plate condenser is then increased, and decreased again until a little before this falling off point. One may then test for stability by knocking the panel with the knuckles and hearing what the monitor has to say (the monitor had better be on another table). A birds' concert would be a warning that the adjustment is not yet perfect, and the condenser R might be increased.

It may be of interest to note that with these arrangements, we have often changed crystals without having to change the L coil, provided frequencies do not differ by more than a quarter of the band or so. The plate condenser achieves the compensating adjustment.

Grid meter readings should be kept low; somewhere near 50 or 60 ma. will do. If they run too high, crystal action must be reduced either by reducing the R capacity, by lowering the plate power or by correcting the L value. Maximum power must never be applied until correct constants have been found. About 400 volts could do to start with, and as stability is secured with low crystal meter readings, power can be increased. The grid should be properly biased. The diagram in Fig. 3 shows a 2000-ohm grid leak for the UV-211.

While the principles involved and the adjustments may seem complicated, when once the latter are found, stable operation can proceed for months on power exceeding 100 watts input without crystal failure.

There is nothing final about the arrangements shown, and the constants indicated can probably be improved on in many cases. We suggest them as a basis for experiment directed towards obtaining better advantage from our crystals.

Strays

WANTED.—Donations of old equipment. The A.R.R.L. plans to get together an exhibit that will show newcomers what the game was like years ago and how important a part amateurs have played in development of radio. It will be a permanent exhibit and will be displayed throughout the country at conventions, shows, etc. The donors of equipment will be given credit for their cooperation by suitable signs. If you have anything at all that you think we could use, will you write us, listing the pieces. Tnx.

Detroit Police and Amateurs Coöperate for Emergencies

By Kenneth F. Conroy, W8DYH*

AMATEUR radio, we know, has in hundreds of instances been of invaluable service, functioning in emergencies to relieve suffering, establishing communication when wires are down. This, to our minds, has been one of the strongest reasons, supplementing others, to insure our government's continued allocation of operating frequencies to radio amateurs.

During past emergencies many of the amateur emergency stations have experienced considerable interference from stations operating in normal ham work—exchanging reports, testing, rag-chewing, and handling less important traffic.

While attempting to help out during the California earthquake, local interference was severe. One station was even playing music and blanketing the air for others. There was nothing to do but stop and wait. There were stations CQing on the frequencies of California stations and discussing very much less important things than the earthquake. All this interference while unintentional perhaps would not have been caused had the responsible parties been aware of the 'quake.

When there is a disaster of such proportions, and even in important local emergencies, the amateur bands should be clear of all transmissions excepting, perhaps, pre-scheduled ones. It is our first individual responsibility to keep down interference and to cut even prearranged schedules to the limit. All stations must coöperate fully with the station or stations in the stricken area! The rest of us should be listening and ready to transmit but not transmit unless we are needed.

It may be impossible to achieve a Utopian condition or avoid interference altogether in emergencies. In Detroit we have worked out a plan utilizing the police radio coordinating agency and police radio to inform amateurs of emergency conditions promptly if and whenever such conditions arise to increase the efficiency of our amateur radio work in emergencies. We report our plan as a suggestion to hams in all other communities where police radio service is effective.

The various police radio systems (and there

* A.R.R.L. SCM Michigan, 7538 E. Robinwood Ave., Detroit, Mich.

are a great number in these United States) operate on a 24-hour a day—7-day a week basis. Newspaper reporters also usually coöperate closely with police dispatches and radio operators. So the police of each community have first-hand dope on both national and local emergencies. Police radio scout cars are assigned to patrol certain areas of the city. The cars do not have a set schedule and usually may double back on streets just covered, or do whatever police work the crew finds most important just as long as the car stays within its assigned territory and one man stays in the car to receive an emergency call.

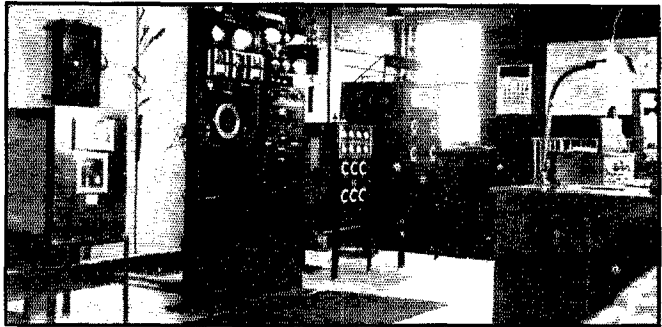

DETROIT POLICE WCK-WPDX

Amateur radiomen are a willing group, ready to help in any worthwhile cause. Individuals of the group have stations always in readiness, but lack facilities to tell just when they are most needed. Unless they happen to be on the air and get "wind" of the disaster, normal amateur schedules may not bring emergency information until too late. Evening papers may not carry late news, but we have a police radio system giving continuous service. Police cars cover every section of the city. They pass the shack of every amateur in the city at will and can deliver a message of any disaster taking place. These cars are in instant touch with their headquarters by radio. Regular police business will not be interrupted in any manner by supplying these facilities to radio amateurs. It is logical to plan coöperation between police and amateur services looking to possible emergencies, for the results can only reflect credit on both services and result in improved benefits to the public.

In the Detroit Police Department, the pion-

(Continued on page 62)

A.R.R.L. All-Section Sweepstakes Contest

Fifth Annual League QSO Party Dates November 17th to 26th—Take Part and Report—All Hams Invited (W, VE, K, KA, CM, VO's)—Certificate Awards for Winners Each A.R.R.L. Section—Plus Affiliated Club Awards in Local S.S. Contests—New Power Equalizing Factor

By F. E. Handy*

THE highest scoring stations will have literally "swept the air," piling up points by skillful operating work . . . hence the name "Sweepstakes." This has become one of our most interesting and popular operating activities. The contest is extremely simple. It is of interest to determine how many stations can be worked! If you have never tried to work "all Sections," take this as an opportunity to try it. You will add new Sections, and new stations. Any frequency bands can be used, and either voice or telegraph.

All North American hams are invited to try their hand in the "S.S." Any amateur station in the U.S.A.¹ or Canada can take part. Each station works as many other stations as possible working in as many different A.R.R.L. Sections² as possible in the contest period. As necessary proof of "solid" QSO, a short message will be exchanged. Two week-ends and the time between them, nine days in all, will be available for participation. Fullest operating enjoyment is assured. In the last S.S. W6AHP made 30,888 points on 14 mc. 'phone, and W9ACU a third as many using a 10 watt 'phone! W9UM (c.w.) worked 65 of a possible 69 Sections! 77 participants worked more than 50 Sections. W9AUH, high national score of 62,622 worked 495 stations in 63 Sections. Fun? Read page 90 of May *QST* once again. Ask any amateur who took part last year!

A test of your station's performance in communicating! New friendships, a chance to work new states and Sections, to improve operating ability and operating efficiency. Plenty of good operating fun available . . . true ham spirit in it all. Ours is a fraternity and the "S.S." has grown in popularity each year.

The contest runs from Saturday, November

17th, through Sunday, November 25th (into early Monday, November 26th).

THE CONTEST PERIOD

Time	Starts	Ends
A.S.T.	Nov. 17th, 5:00 a.m.	Nov. 26th, 5:00 a.m.
E.S.T.	Nov. 17th, 4:00 a.m.	Nov. 26th, 4:00 a.m.
C.S.T.	Nov. 17th, 3:00 a.m.	Nov. 26th, 3:00 a.m.
M.S.T.	Nov. 17th, 2:00 a.m.	Nov. 26th, 2:00 a.m.
P.S.T.	Nov. 17th, 1:00 a.m.	Nov. 26th, 1:00 a.m.

THE GENERAL CALL

"CQ SS CQ SS CQ SS de W . . . W . . . W . . ." is used by stations looking for contacts in the Sweepstakes. During the active operating hours a single snappy CQ SS or QRZ SS? will bring results!

POWER HANDICAP

The following multiplier will be used to give all stations an equal chance. If the power input to the final stage (plate current times plate voltage— $E \times I$) is:

- Up to and including 25 watts—multiply score by 3
- Over 20, and up to 75 watts—multiply score by 2
- Over 75 watts—multiply score by 1

KEEPING SCORE

As contacts are made keep a list of stations, their A.R.R.L. Section and the number of points for each QSO. Each station (c.w. to c.w. or

* There is no point in working the same station more than once in the contest period if two points have been earned by exchanging messages. If but one point is made the first time you can add a point by working this station again and handling a message in the opposite direction.

² The highest individually-attained score of any one of the operators of amateur stations having more than one operator is the official score for such a station. The summary of score must show all stations worked by all operators however, underlining, or circling the entries of stations and/or Sections that cannot count in the official total. Awards will be based on the official total and will be made to the individual operator accredited with this total. To show the possible scores that can be built up by several operators at one station, such scores (all Sections listed by all points listed) may be shown parenthetically after the "official" score that counts toward a possible award.

* Communications Manager, A.R.R.L.

¹ Including Cuba, Porto Rico, Hawaii, Alaska, P. I., etc. Amateurs in Newfoundland are included in the Maritime Section of the A.R.R.L. field organization.

² See the complete list of Sections in the A.R.R.L. organization, page 5 of this issue of *QST*.

³ "Handling" a message always includes the transmission and receipt of radio acknowledgment (QSL) of same, and entry of date, time and station call on the traffic, as handled, for purposes of record. All messages should be handled in standard A.R.R.L. form.

'phone to 'phone) worked can contribute a possible two points. A message received counts one; a message sent counts one. More messages may be handled,³ but add no more to the score. At least *one* message must be handled between two stations as "proof of QSO"⁴ before points or Sections can be claimed. These exchanges have been simplified to the minimum for "proof of contact" at the same time they enable operators to keep in form by permitting short snappy texts. C. W. telegraph to 'phone station contacts count a possible three points per QSO. (1½ for message sent, 1½ for message received).

At the end of the contest add all the points. Count the number of different A.R.R.L. Sections worked (those with which at least one message has been handled). Multiply the sum of your points with individual stations by this number. (There are 69 Sections² in the League's organization so this is the greatest possible multiplier.) Next multiply your total by the proper power handicap⁶ as mentioned above. Keep the summary of your score in the form suggested. List all operators⁵ whose work at your station is responsible for any part of the score.

LOW POWER MAKES GOOD

Last year W8FDA worked 41 Sections for a score of 9,553 points using a single '71A (with 200 volts B) for a transmitter. W1DUJ, W8AQE, W5BD and others made similar records. In fact

practically 30% of the fellows taking part used a single '10, and another 25% either a pair of '45s or '10s. They made good before we had the power handicap, so don't let "power" considerations deter you. Let us know who can make the best low power record. Report all work. Real operating ability is far more important than power.

'PHONE WORK

'Phone possibilities are unlimited. This year the scoring rule is changed so that every 'phone

to c.w. station QSO gives 150% credit, for both operators (1½ points for msg. sent; 1½ points for msg. rec'd . . . a possible 3 points). What 'phone operator can break W6AHP's record of the last S.S.?

SHORT MESSAGE EXCHANGE TO PROVE QSO RELIABLE

"Contest messages," each of at least five words text, will be sent to create proof of solid contacts, except when regular amateur traffic is sent or received (which it should be when it can be routed

(Continued on page 84)

⁶ If the power was changed between (a) (b) or (c) during the contest the individual points should each be multiplied by the proper multiplier for the power used for those particular contacts. When the power was constant throughout the contest (or if power was kept within limits of a, b, or c when changes to other amateur bands were made) it is simpler to use the power multiplier last in computing the score.

⁷ All hams are requested to submit lists, even if they only show a small score on a postal. By doing this they help support claims made in logs from other stations, and also they receive full credit in QST.

⁸ "Sent" and "received" are indicated as S and R in this summary.

STATION WAVE . . . SUMMARY OF CONTACTS 5TH ALL SECTION S.S. CONTEST

Date and Time (local)	Station Worked	Freq. Band (mc.)	City or Town	A.R.R.L. Section	List Different Sections	TFC*	Points
Nov. 17th							
4:05 a.m.	W1FAJ	3.5	Adams, Mass.	W. Mass.	W. Mass.	1-S 1-R	2
4:19 a.m.	W6DJI	7	San Francisco, Calif.	S. F.	S. F.	1-S	1
2:08 p.m.	W9GHI-F	3.9	Baldwin, Kansas	Kansas	Kansas	1-S 1-R	3
3:16 p.m.	W8ALC-F	3.9	Defiance, Ohio	Ohio	Ohio	1-S	1½
Nov. 24th							
11:00 a.m.	W9KEH	3.5	East St. Louis, Ill.	Ill.	Ill.	3-R 1-S	2
12:08 p.m.	W9COH	3.5	Waukegan, Ill.	Ill.	Ill.	1-S 1-R	2
12:25 p.m.	W6BIL	14	Tulare, Calif.	San Joaquin Valley	S. J. V.	1-S 1-R	2
12:48 p.m.	W2ERM	14	Tuckahoe, N. Y.	E. N. Y.	E. N. Y.	1-S 1-R	2
Nov. 26th							
3:37 p.m.	VE5EC	14	Victoria, B. C.	B. C.	B. C.	1-R 1-S	2
6:45 p.m.	W6DJI*	7	San Francisco, Calif.	S. F.	S. F.	1-R	1
8:09 p.m.	W9BWF	7	Redfield, Iowa	Iowa	Iowa	1-R 1-S	2
					9 Sections		20½ points

Number and name of operators having a share in above work
 Claimed score: 20½ points × 9 Sections = 184½, 184½ × 2 (64 watts input) = 369
 I hereby state that in this contest I have not operated my transmitter outside any of the frequency bands specified on my station license, and also that the score and points set forth in the above summary are correct and true.

Also please note this score in our affiliated-club S.S. contest as well as in general participation record.

Name of Club Secretary's address
 My Tube line up:
 Power Input:

Signature Call
 Address
 Club Member
 Prospective Club Member

* Note this is a second QSO (W6DJI worked twice). F shows c.w. to 'phone contacts with 150% credit.

What the League Is Doing

League Activities, Washington Notes, Board Actions—For Your Information

Election To all A.R.R.L. Members residing in the Southeastern Division:

Notice You are hereby notified that J. C. Hagler, Jr., has resigned as A.R.R.L. Director from the Southeastern Division, his resignation to become effective upon election of a successor. You are also notified that a special election for A.R.R.L. Director is about to be held in the Southeastern Division to fill the remainder of the 1934-1935 term left vacant by this resignation. Your attention is invited to Section 1 of Article IV of the Constitution, providing for the government of A.R.R.L. affairs by a Board of Directors; Section 2 of Article IV defining their eligibility; and By-Laws 10, and 12 to 20, inclusive, providing for their nomination and election. Copy of the Constitution and By-Laws will be mailed any member upon request.

The election will take place during the period between December 15, 1934, and February 1, 1935, on ballots which will be mailed from Headquarters in the first week of that period. The ballots will list the names of all eligible candidates nominated for the position by A.R.R.L. Southeastern Division members.

Nominating petitions are hereby solicited. Ten or more A.R.R.L. members of the Southeastern Division have the right to nominate any member of the League in that division as a candidate for director therefrom. The following nominating form is suggested:

(Place and date)

Executive Committee

*American Radio Relay League
West Hartford, Conn.*

Gentlemen:

We, the undersigned members of the A.R.R.L. residing in the Southeastern Division, hereby nominate of as a candidate for director from this division for the remainder of the 1934-1935 term.

(Signatures and addresses)

The signers must be League members in good standing. The nominee must be a League member in good standing and must be without commercial radio connections; he may not be commercially engaged in the manufacture, selling or renting of radio apparatus or literature. His complete name and address should be given. All such petitions must be filed at the headquarters office of the League in West Hartford, Conn., by noon of December 15, 1934. There is no limit to the number of petitions that may be filed, but no member

shall append his signature to more than one petition.

This election is the constitutional opportunity for members to put the man of their choice in office as the representative of their division. They are urged to take the initiative and file nominating petitions immediately.

For the Board of Directors:

A. L. BUDLONG,
Acting Secretary

October 1, 1934

Lisbon As we write this, the C.C.I.R. Conference in Portugal has just got under way, and aside from the cabled news that Secretary Warner and Technical Editor Lamb arrived safely at Lisbon a day or so ahead of the opening of the sessions, we have no news to report. Members interested in some of the details as to the scope and purpose of this international gathering are referred to the item on the C.C.I.R. on page 29 of September *QST*.

It may be interesting to know that due to inability to make proper arrangements for the sessions at Lisbon, the conference is holding forth at the nearby sea-side town of Estoril, about half an hour's train ride distant from the capital.

Elections About the time this issue reaches you, members in seven of the League's divisions will be receiving ballots in connection with the annual elections for directors. As has been pointed out in the election notices and in the account of the 1934 meeting of the board, and as will be apparent from the ballots themselves, this year sees two new features in connection with director elections. First, there is the provision for election of an alternate director, and it is apparent from nominations already in the hands of the Executive Committee that alternates are being nominated in several of the voting divisions, at least. Perhaps the status of the alternate director is not clearly understood.

He is not an "assistant director," and directors still have the right to appoint assistants (as many have already done), nor does he become the director in the event of resignation of the director between elections. His principal reason for existence is to insure his division a vote at the board meeting in the event the director cannot attend. Heretofore a non-attending director has had the constitutional right to send an "alternate" to the board meeting in his place, but because of Connecticut corporation law that alternate has

(Continued on page 62)

The Directive Antenna at KAINA

By D. C. Redgrave*

MANY amateurs have written asking for information about the beam antenna system which has been in use at KAINA since late December, 1933. Here is the story of its construction and use, together with data which should be of assistance to anyone in building a similar system.

After spending a large part of the 1932-1933 DX season in efforts to contact the northeastern part of the United States on 7 mc. without success, it was decided to erect a large beam antenna for the following season. The power used was definitely limited by d.c. supply and the inability to obtain the use of a motor-generator having higher than 1500 volts rating. Using a match-impedance antenna, half-wave, and a 600-ohm line from the transmitter, which is located about 400 feet from the antenna, an input of 600 watts to a pair of 11-D tubes in the final stage could be obtained. The final stage was operating at a plate efficiency of 65%. This was the general layout from April, 1933, until late December, 1933.

Work on the beam antenna started in December, but before breaking down the old antenna, measurements were made of the r.f. current distribution along the transmission line. A standing wave having a ratio of maximum current to minimum current of 3 to 1 was found to exist on the line, in spite of the fact that the line supposedly was matched to the antenna by the use of the regular formulas and that the wires in the line were accurately spaced. This was something of a surprise and steps were immediately taken to correct the condition, using an open-ended stub line or "building-out section"¹ on the transmission line, in accordance with the method to be described. On the first trial the standing wave was reduced to a ratio of 1.7 to 1 and the input could be increased to 800 watts with the same plate dissipation. This indicated higher efficiency and greater output.

THE BEAM ANTENNA

It was decided to build a "V"-beam and tilt it forward in the direction of propagation in order to obtain a theoretical gain of twice that to be expected from a horizontal beam.² The house is completely surrounded by tall coconut-palm and

acacia trees, which made it necessary to erect the antenna at some distance from the transmitter. The general shape of the clear space dictated the type of beam selected. In the "V"-beams, the greater the number of waves on each leg of the "V" the smaller the angle between legs. A beam having two full waves on each leg and an angle

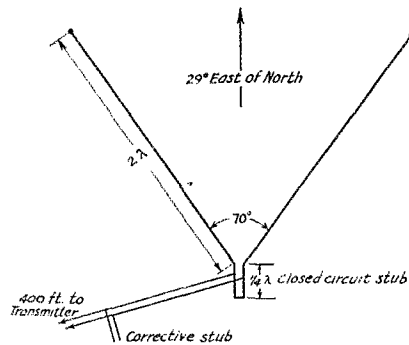

FIG. 1—GENERAL PLAN OF THE DIRECTIVE ANTENNA AT KAINA

It is of the "V" type, with a quarter-wave coupling line or "linear transformer" at the feed point. The drawing also shows the corrective open-ended stub used to eliminate standing waves on the long transmission line.

of 70 degrees between legs fitted in well with the space available and was selected.

Fig. 1 is a bird's-eye view of the layout with the quarter-wave antenna-coupling stub flattened out. Fig. 2 is an attempt at a perspective view which shows all elements more nearly in their actual position. Such a system could have been fed directly without dropping down the coupling stub line by using tuned feeders, but heavy wire would have been required for the feeders and, even so, the losses would have been high with such a long tuned line. The old 600-ohm line was therefore used and matched to the antenna by using a quarter-wave stub line to obtain a point of maximum current at the center of the system. The point of attachment of the 600-ohm line to this coupling stub was determined by trial-and-error. Measurements of the antenna current and the ratio of I_{max} to I_{min} on the transmission line were recorded with the point of attachment up 7, 9, 11 and 13 feet from the bottom of the stub. Curves were plotted, and the point giving the greatest antenna current with the lowest ratio of I_{max} to I_{min} (hereafter referred to as "X") was picked from the curves and the line attached at this point. The antenna was cut for 7260 kc. and the line attached up 11 feet 6 inches

* Ex-KAINA, Navy Yard Division, Navy Department, Washington, D. C.

¹ Sterba and Feldman, "Transmission Lines for Short-Wave Radio Systems," *Proceedings of I.R.E.*, July, 1932, pages 1182 and 1183. — EDITOR.

² An elementary form of the R.C.A. Model D antenna. See Carter, Hansell, Lindenblad, "Development of Directive Transmitting Antennas by R.C.A. Communications, Inc.," *Proceedings of I.R.E.*, October, 1931. — EDITOR.

from bottom of the stub. With this point of attachment "X" was equal to 5, indicating a rather poor match between line and antenna; a high antenna current resulted, however, and the standing wave could be reduced by the use of a "building-out section" on the line. With each adjustment, the final stage was returned to resonance.

Fig. 3 shows the method used in measuring the current distribution along the line, using an r.f. meter bridged across a length of one wire of the line. The concave surfaces of the wire hooks

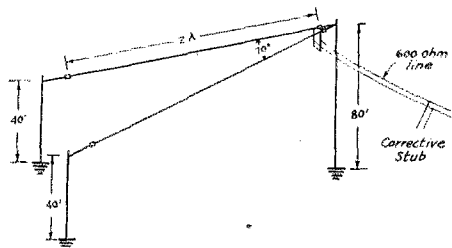

FIG. 2—PERSPECTIVE VIEW OF THE ANTENNA SYSTEM

The forward tilt from the horizontal, accomplished by using a higher mast at the tip of the "V" than at the open ends, adds to the directivity.

should be sharpened in order to make good contact with the wire in the transmission line. The dimensions of the device should suit the height of the line above ground so that it can be conveniently moved along one wire at a time as measurements are being taken. The greater the distance between hooks, the greater the portion of the line across which the meter is bridged and the greater the reading of the thermo-milliammeter for a given current in the line. If readings are being taken at a voltage loop, higher scale

TABLE I
LENGTH AND POSITION OF IMPEDANCE-MATCHING STUB LINE FOR VARIOUS "X" RATIOS

"X"	"A"	"B"
Ratio $\frac{I_{max.}}{I_{min.}}$	Distance from $I_{min.}$ to stub in % λ	Length of stub in % λ
1.00	12.4	0.0
1.25	13.2	3.4
1.50	14.0	6.0
1.75	14.6	8.0
2.00	15.1	9.7
2.25	15.6	11.0
2.50	16.0	12.0
2.75	16.4	12.9
3.00	16.7	13.5
3.50	17.2	14.7
4.00	17.6	15.6
4.50	18.0	16.3
5.00	18.3	16.9
6.00	18.8	17.8
7.00	19.2	18.4
8.00	19.6	18.9
9.00	19.8	19.3

readings will be obtained with only one hook making contact, hence, the weight of the board and meter should be sufficient to insure good contact at both hooks. If insulated wire is used in the line the insulation can be cut by the sharpened edge of the hooks.

The first step is to determine the location of the points of $I_{max.}$ and $I_{min.}$ that are as close to the antenna as it is possible to measure them, because the standing wave will be eliminated from the corrective stub to the transmitter but not from the stub to the antenna. The point of $I_{max.}$ will be easier to locate than $I_{min.}$ because the meter can be read with greater accuracy at high scale deflections. Going from the $I_{max.}$ point about a quarter wave, toward the antenna, the point of $I_{min.}$ should be located. This should be checked by taking readings along one wire of the line every few feet or so. Having located the point of $I_{min.}$ nearest the antenna in one wire, the other wire should be checked to see if its $I_{min.}$ is directly opposite. Two percent of the wavelength is the permissible variation in position of $I_{min.}$ but if the line is laid out symmetrically with reasonable care, the variation should be considerably less than this. If there is more than two percent variation in positions, the length of the one wire should be changed near the antenna to restore symmetry.

CORRECTIVE STUB TO REDUCE STANDING WAVES

Having located $I_{min.}$ and $I_{max.}$, their values should be read carefully. The ratio of the latter to the former gives us "X". Once "X" has been determined we are ready to make use of Table I.

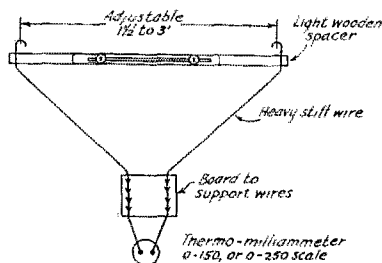

FIG. 3—LINE-CURRENT MEASURING DEVICE

Distance "A" and length "B" are taken for the value of "X", interpolation being used between the values given. Note that the distance "A" is measured from the point of $I_{min.}$ toward the antenna. Probably the easiest way to make these measurements is to convert wavelength into feet and then multiply by the percentages taken from the table. The open-ended stub line is made up of the same size wire used in the transmission line and similarly spaced. After attaching the corrective stub, measurements of the current distribution on the line between the stub and the transmitter can be made and slight changes

in the position and/or length of the stub will result in almost complete elimination of the standing wave on the line. On the first trial we found that the ratio "X" had been reduced from 5 down to 1.9, a great improvement. Since it was more convenient to change the length of the stub than its position, we tried lengths slightly more and slightly less than those taken from the table, plotted a curve of antenna current against stub length and picked off the length which gave the best results. It was within five percent of the length taken from the table, the difference in antenna current with this length and that taken from the table being hardly measurable. The final "X" was 1.17, indicating almost complete elimination of the standing wave. The result of this work on eliminating standing waves on the line was twice the power in the antenna with an increase of but one-third in transmitter input. This was accomplished with no increase in plate dissipation.

As an example of the use of this method of eliminating standing waves from a line, suppose the frequency is 7100 kc., equivalent to a wavelength of 42.3 meters or 138.7 feet. Assume that I_{max} is 217 milliamperes as recorded on the thermomilliammeter and I_{min} 70 ma. This gives an "X" of 3.1. Consulting the table and interpolating between 3.00 and 3.50, we get: A=16.8% and B=13.74%; 16.8% of 138.7 gives 23.3 feet as the distance from the I_{min} point nearest the antenna out to the point of attachment of the stub, measured in the direction toward the antenna. And 13.74% of 138.7 gives us 19 feet as the length of the open-ended stub.

ANTENNA GAIN ACHIEVED

Results obtained from the beam antenna were most gratifying. W4FT was worked at 2230 GT the day after it was erected and W1ZI a few days later about the same time. A twice-a-week schedule was maintained with W1ZI during the months of January, February, March and part of April, when mid-summer receiving conditions at this end made extreme DX on 7 mc. no longer possible. Numerous stations along the East Coast were worked at this time of the day and several W8's and W9's contacted. Schedules were maintained with W8ZY and W8BTI for about a month. Although our signals were reported much stronger on the East Coast between 1100 and 1200 GT, only two QSO's, one with W1ZI and one with W4CBY, were made at this time because of our inability to hear the East Coast Stations. During our Sunday DX tests, we had many stations covering the band for replies; several of these had the latest type receivers with doublet receiving antennas, but the East Coast signals could not cut through the heavy QRN, which lasts for several hours after sunset.

Due to absorption by nearby trees, field strength measurements taken near the antenna

possibly do not give a true picture of its directional characteristics. After studying hundreds of reports on signal strength, it is our opinion that the beam has resulted in a gain of two points on the "R" scale of signal strength in the approximate direction of maximum propagation. This represents a gain of some 8 db or the equivalent of using 6 or more times the power input on a regular half-wave antenna.

The beam was pointed on a Great Circle

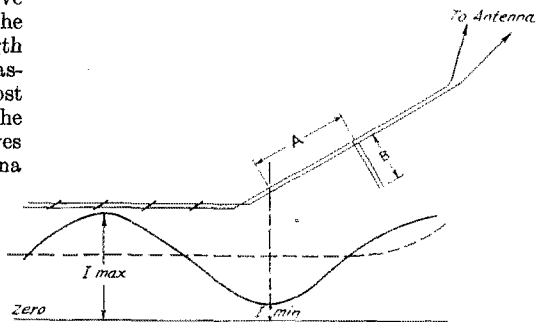

FIG. 4—RELATIVE CURRENT DISTRIBUTION BEFORE AND AFTER ATTACHING THE CORRECTIVE STUB

The heavy line shows the variation in line current without the stub; the dotted line the current distribution after the stub was attached. Elimination of standing waves on the line made possible an increase in both output and efficiency of the amplifier stage feeding the transmission line.

course to Washington, D. C., which was picked off a globe by stretching an elastic band between two pins. Because of the beam's spread the system works well for all DX to the East, and since the fringe of the beam passes over the North Pole we might expect it to work especially well for all extreme DX from its P.I. location. Theoretically, the beam should give greatly reduced radiation in other directions, but results show that there is an approximate gain of 3 db in all directions over the fundamental antenna, probably due to the large expanse of the radiating system. Thus, one who is fortunate enough to have the space to erect one of these beams can still contact stations in the "wrong" direction which could be worked on a half-wave Hertz. A somewhat greater gain in the direction of principal propagation, and a reduction in gain in other directions could have been obtained by increasing the forward tilt of the antenna. Thus the two short poles might have been made 20 feet high instead of 40 feet. In our location, we had to clear trees which made the greater height necessary. The system should be fed at the point of the "V," at the high pole, which should be at least a half wave-length in height. The antenna shows approximately the same gain when used for reception, but we seldom used it for this purpose after finding out that it could not bring in

(Continued on page 74)

High-Power 'Phone DeLuxe

A Ham's-Eye View of the Transatlantic Telephone Transmitters

A. W. Anthony, Jr., WICTE*

INSTEAD of just dropping in, we 'phoned the main New York office of the A. T. & T. to get permission to visit the Lawrenceville transatlantic 'phone transmitting station; we were connected—gratis—right through to the chief in charge at Lawrenceville. His voice carried the ring of sincere cordiality as he urged our making the trip. So a date was arranged and full instructions were received.

Steel towers supporting the antenna systems appeared through the trees soon after leaving Princeton, but they are relatively low compared with those of the long-wave stations, such as New Brunswick and Marion, Mass. Entering the property, the antennas seemed a hopeless maze of wires, but after a time different components such as radiators, reflectors and phase shifters, supported by the towers in orderly sequence, could be recognized; while on the ground, on short wood poles, there were transmission lines, coupling units, etc., supported by pin- and strain-type insulators of Pyrex and Isolantite.

Following instructions, we passed the first building and went on to the second, a good half-mile beyond. Parked the car, rang the doorbell, were admitted. "Mr. Yahnel is expecting you upstairs." A glimpse of motor generators on the first floor. Upstairs, a short corridor, an open space between two transmitters containing speech-control and monitoring equipment—not to mention two operators who greeted us royally, had us sign the guest book, let us listen to "scrambled" incoming voice from New York. An attempt to beat the gun by looking at transmitters was gently but firmly nipped in the well-known bud, and we embarked upon the visitors' routine, starting logically with the incoming voice lines. These terminate in a carefully shielded room containing pertinent testing and measurement apparatus, as well as standard telephone repeater equipment.

* 31 Horne Road, Belmont, Mass.

First, let's have the general picture. There are three channels to England, one to South America, and one to Bermuda. Each channel has a complete transmitter; one of the English transmitters is assigned five frequencies and all the others have three frequencies, to allow for the vagaries of daylight, night, and twilight transmission. Two identical buildings were designed to house the English and S. A. transmitters, but the Bermuda transmitter was added later—and nobody felt crowded.

The transmitters at first glance impressed this ham as being rather lacking in meters and dials, there being vast open spaces of black shiny metal panel; reasonable enough, however, since there was plenty of space, and small meters and dials can serve just as well as large. The power control panels across the aisles, however, nobly satisfy the amateur's yen for meters, handwheels and gadgets. Here are concentrated complete controls for everything not r.f. or a.f.—meters, switches, signal lights, relays, delays, and protective devices galore. Master control may be selected, so that simply by pressing the proper button all equipment starts automatically and in correct sequence, and is brought to operating condition before the next step is taken—excepting only application of high voltage to the final amplifier; similarly, a "stop" button shuts it all down. A large group of signal lights, together with appropriate relays, indicate which switches have worked automatically, simplifying searching in case of trouble. An elaborate system of mechanical and electrical interlocks is provided—and when I say "elaborate," I mean exactly that—as many as five separate and distinct keys being required before certain compartments may

be entered or their circuits worked upon. This safety system is applied throughout the whole plant, from the primary three-phase power circuit breakers, through the substations, control panels, transmitters, and on even to the very last an-

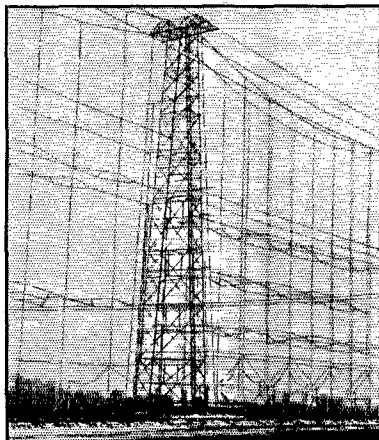

THIS 180-FOOT TOWER IS ONE OF A LARGE NUMBER CARRYING THE DIRECTIONAL ANTENNA ARRAYS

The short poles in the foreground hold the linear impedance-matching transformers coupling the transmission line to the antenna.

tenna disconnecting switch. When the rigger, for instance, works on an antenna, he locks the switch open and puts the key in his pocket.

D.c. at 10,000 volts is supplied from a six-phase half-wave transformer and rectifier using six two-element vacuum tubes with water-cooled anodes. Rectifier filaments are heated by a.c., each from an individual transformer. There are two complete rectifiers in each building, and three complete transformer equipments, with double-throw switches to permit use of the spare with either rectifier—but with interlocks to prevent operating both rectifiers from the one spare. Transmitter filaments are heated by d.c. from motor generators, carefully filtered; 400 amperes at 24 volts is normal load per transmitter. Three complete sets of filament and bias motor generators are arranged to serve the two transmitters—with interlocks!

Now for the transmitters: Apparently the general scheme is similar to that of many amateur 'phones—crystal oscillator, frequency doublers and/or triplers (at Lawrenceville they call 'em "harmonic generators"), Heising (plate) modulation, followed by linear amplification—with one important difference, as we shall see.

Four of the transmitters in the two buildings are identical, occupying floor spaces 20 feet long by 4 feet deep, and are 7 feet high. They are capable of covering frequencies from 3 to 25 megacycles, with unmodulated carrier power of 15,000 watts, hence 60 kw. on the peaks at 100% modulation. Six 10-kw. water-cooled tubes comprise each output stage, push-pull with three in parallel on each side. In these transmitters output from the telephone repeaters is first amplified by a 50-watt tube, followed by four 250-watters of the 212-D type, Class-A; these modulate the output of two 250-watt tubes self-oscillating in a special circuit but controlled by crystal; this modulated r.f. excites a push-pull intermediate linear amplifier of two 10-kw. water-cooled tubes, which in turn drive the six 10-kw. tubes of the final linear amplifier. Note, however, that the two 250-watters *do oscillate*, and oscillate at carrier frequency; and that they

are modulated; but their frequency is controlled and held rigidly constant by the crystal *via* the harmonic generators; all the crystal does is keep the frequency from drifting one way or the other.

Frequencies are held within 0.01%, less than a fifth of the government tolerance.

The 10-kw. tubes, developed by Bell Telephone Laboratories especially for this transatlantic telephony, are double-ended: filament at one end, grid at the other, cylindrical copper water-jacketed plate in the middle surrounding the grid and filament. A plentiful supply of tank coils of the bolt-on variety, to accommodate each of the assigned frequencies, is neatly stowed in a cabinet. At the highest frequencies, however, even straight conductors of the lengths necessary have too much inductance, and the 21-mc. tank coil actually is a bar of copper split lengthwise to make two parallel conductors, one straight, the other slightly curved—thereby reducing the inductance, so I was told. Neutralizing condensers are cylindrical oil-filled affairs of concentric copper tubing, about 3 inches outside diameter by 24 inches long, set at steep inclines to cross over from the grids of each side of the push-pull amplifier to the plates of the other side. Oil is used because of its higher

insulating value and its high dielectric constant—about three times that of air. The first high power stage has for its tank condenser one of those big Cardwell balanced brutes with gear drive (list price \$450.00!). The final stage apparently needs no lumped variable capacity, as it is tuned by metal vane or disc inserted into or withdrawn from the lumped inductance. Thermo-amperes in tank circuits are conspicuous by their absence but in their stead small 2-element vacuum tube rectifiers in pairs are connected, through small condensers and high resistances, between ground and the grids and plates of each of the high power stages to indicate peak voltages. The sums of these rectified currents are of greatest interest, but unbalance will show up by their differences. Those connected to the plates of the final stage also supply the output monitor which checks the actual transmissions. We got there just too late

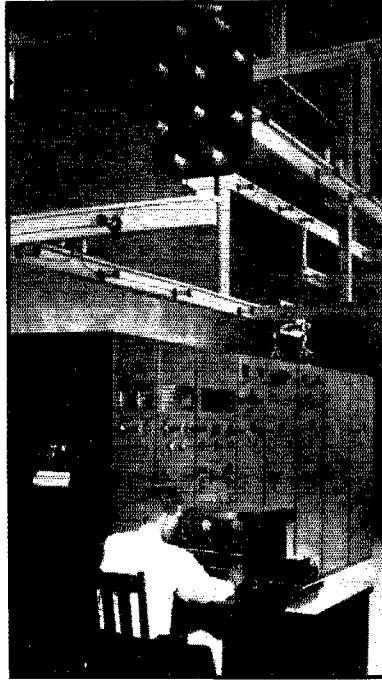

ONE OF THE 15-KILOWATT TRANSMITTERS FOR OVERSEAS TELEPHONE SERVICE

The operator in the foreground is at the monitoring position. Six 10-kw. tubes in push-pull-parallel form the final linear stage of this crystal-controlled transmitter. The recorder mounted on the end of the transmitter assembly keeps a graphical record of crystal operation.

to see a transmitter changed to another frequency—tough luck indeed.

These transmitters put on the air whatever comes over the land line from New York, all "scrambling" (properly known as "voice frequency inversion") being done there. Further privacy is provided by a continual small variation or wobble up and down of the crystal frequency through two or three hundred cycles, the rate of wobble being variable up to maybe 125 times per minute. The receiving apparatus of course has to compensate for all this—difficult, but being done right along. It certainly is completely secret as far as I am concerned. There is at present no suppression of carrier or side band, although the possibility of this has been provided for.

The tube engineers have a wonderful room especially equipped for checking and testing the large tubes, with an individual 15,000-volt power supply. You hams with set analyzers should take a couple of looks at this room, with its switchboard panels, able to give any kind of a test, static or dynamic, loaded or light, conveniently and quickly—but fenced in, with omnipresent interlocks to the fifth power! There is a rack full of water-cooled tubes tested or awaiting test. Yes, and a swell junk box, full of tubes the worse for wear, grids, plates, bases, an indescribable mass of tube metal—destined to return to Bell Telephone Labs, maybe for another chance. Tube stock doesn't seem to be so large, due no doubt to the nearness of the source of supply. In spite of gentle hints, no one presented me with any tubes, new or second-hand, as a memento of the happy occasion. Too bad.

In quick review, we looked at the small 1-kw. set for the Bermuda channel, passed through executive offices, the general storeroom (and *that* was somepin', too), the operators' locker- and

rest-room (with 212-D bases as ash trays, Hil). Downstairs, around the motor generators. Saw the sleet-melting equipment which can circulate 60-cycle current at about 150 amperes through the antenna systems even while transmission is going on; the cooling water apparatus, the main transformers. Being then outdoors, we departed, deeply impressed by the technical excellence of the equipment but even more so by the warm invitation to "Drop in again."

Driving out, we looked more closely at the antennas, which are complicated affairs from the ham point of view. There are sixteen distinct antennas, eleven for England, four for South America, and one for Bermuda. Rugged steel towers 180 feet high, 250 feet apart (except those for the 45-meter antenna, which are 365 feet apart); 21 towers in a row a mile long for England, 7 in the row for South America, forming a huge "V." Two panels of radiators between three towers constitute an antenna; second similar panels a quarter-wavelength behind the first act as reflectors to augment the directional effect. The net result of this antenna system is the maintenance of commercial signals *at the point wanted*, with the use of about one thirtieth of the power that would be needed in a non-directional antenna—which means a lot in dollars, both in first cost and operating expense. Antenna wire is No. 6 B & S solid, bare, medium hard-drawn copper, inside the buildings as well as in the panels and transmission lines. Three riggers or linemen are regularly employed on antenna construction and maintenance.

At Lawrenceville we heard some about the receiving station for the transatlantic circuits, located at Netcong, N. J., in a section far removed from QRN of all sorts; but we did not have time

(Continued on page 84)

Navy Day Receiving Competition— October 27th

All amateurs are invited to listen and copy the telegraphic transmissions addressed to radio amateurs from NAA and NPG on Navy Day, October 27th. Forward your copies for grading to the A.R.R.L. Communications Department, West Hartford, Conn. Twenty-five letters signed by the Secretary of the Navy will be awarded to the amateurs submitting the best copies. The transmissions made on the following schedule will follow a five-minute CQ call:

From Washington: NAA, 9:00 p.m. E.S.T. simultaneously on 4205, 8410 and 12,615 kcs.

From San Francisco: NPG, 7:05 p.m. P.S.T. simultaneously on 4385 and 8770 kcs.

The Relay Rack in Amateur Construction

By G. Robt. Mezger, W2BLL*

AT SOME time or other, every amateur has had the desire to give his station the prized appearance that is reputed to accompany all commercial installations. In past amateur designs, the first thought toward making the station presentable was the installation of a so-called "rack"—a four-posted frame which ranged through all sizes from small two-panel table models to large affairs that took up a whole corner of the room. The trouble with the four-posted "rack" is that it is big and clumsy, and in spite of the accessibility which its proponents claim it offers, still leaves the constructor very much wrapped around equipment when something goes haywire and a condenser discharges through him.

For the amateur who has to locate his equipment in the least possible space the true relay rack (no doubt the origin of the term "rack" applied to the four-poster) offers several advantages. The area required by the relay rack is approximately 20 by 16 inches. The compactness of relay racks enables the operator to have all equipment under control with a minimum of lost motion in adjustment. Probably most important of all, however, is accessibility. There are no posts in the rear to get in the way. Each unit is independent; it takes but a few minutes for the entire unit to be removed for servicing, and the other equipment is not disturbed. Appearance of the entire station will be improved because everything has a definite place and is kept there.

STANDARD RELAY RACK DIMENSIONS

The standard relay rack consists of two three-inch light-weight structural-steel channels, separated by and welded to bars at the top and bottom to make a rectangular structure. It is supported by steel angles, by lag bolts into the floor, or both; steel angles are usually sufficient for amateur purposes. The secret of the universality of the relay rack is in drilling the panel-mounting holes in the channels, the standard dimensions being shown in Fig. 1. Panel space is provided in multiples of $1\frac{3}{4}$ inches, each $1\frac{3}{4}$ inch being called a "rack unit." All panels are made this height or a multiple of it. Holes are alternately spaced $1\frac{1}{4}$ inch and $\frac{1}{2}$ inch. The rack unit begins and ends half-way between the holes having half-inch separation. The holes are tapped to take 10-24 machine screws of a length dependent upon the thickness of panel used.

A relay rack panel which has been properly drilled and slotted can be turned upside down or

* 4 Park Place, Troy, N. Y.

backside front or moved up and down and always will fit the rack. It is here that the relay rack lends itself so well to amateur construction. When a new piece of equipment is added an entire new layout is not necessary; all the units can be raised the panel height of the new equipment and everything will fit perfectly. For example, if a low-power buffer stage is to be added to an existing transmitter, the unit can be slipped in between a low-power and a medium-power buffer stage or final amplifier.

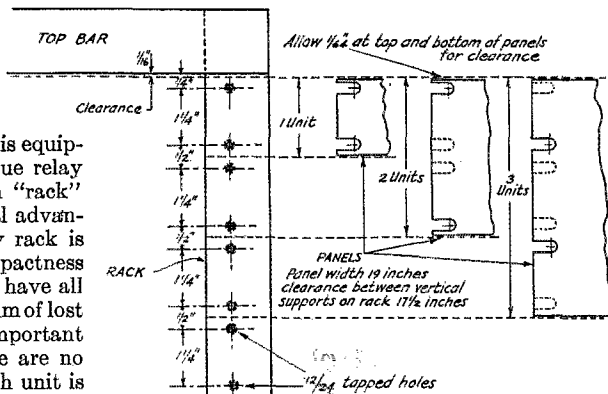

FIG. 1—DRILLING AND PANEL DIMENSIONS OF THE STANDARD RELAY RACK

Since all panels are to be interchangeable, care must be used to cut the edges exactly square, otherwise the panels will not match when equipment is shifted around for changes in transmitter layout. The panels in use at W2BLL are made of fir, with breadboards for the baseboards. A clearance of one inch is left between the bottom of the panel and the bottom of the baseboard to provide space for wiring and small parts such as resistors and condensers. If one is very fussy about appearance, the screws holding the baseboard can be counter sunk and the holes filled with putty or plastic wood. When this has been done, the screws are invisible and the smooth surface of the panel is maintained. It is not advisable to mount the baseboard flush with the bottom of the panel, since in that case any wiring underneath will protrude into the area allotted to the unit below.

BASEBOARD BRACING

The chief problem in relay-rack construction is that of supporting the weight of the equipment on the baseboard. No corner posts rise vertically from the floor at the rear to help carry the weight,

so it becomes necessary for the panel to support the entire load. Since the simple panel-baseboard assembly is not strong enough to support much weight, it is necessary to provide bracing between the rear edge of the baseboard and the top of the panel. One method is to use ordinary shelf brackets mounted in an inverted, or "L," position, one arm extending vertically along the rear of the panel, and the other horizontally along the baseboard. Another way of handling the load would be to run a wire from the top of the panel to the rear of the baseboard, using a turnbuckle to adjust the tension. Pieces of strap iron or brass carpet stripping could also be used.

"DISH" CONSTRUCTION

Braces are a nuisance to construct, however, and invariably get in the way when servicing is

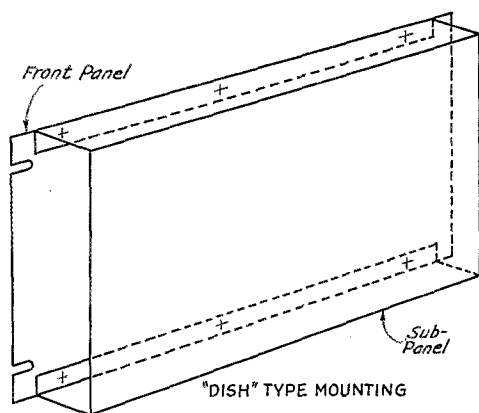

FIG. 2—THE "DISH" TYPE OF SUB-PANEL MOUNTING

The chassis on which apparatus is mounted is vertical. This type of construction eliminates the necessity for horizontal baseboards with attendant bracing.

necessary. A much better method, especially for light-weight equipment, is the "dish" type of construction shown in Fig. 2. This gives all the advantages of mounting equipment right on the panel, and still permits sub-base wiring. The sub-panel need only be separated from the front panel by a distance great enough to allow room for condensers, resistors, and wiring. Tubes can be mounted horizontally. This is likely to give rise to much discussion about filament sag but it is not likely that sag will be troublesome in small tubes, especially when the filaments are mounted in a vertical plane. Sockets are available for mounting large power tubes at right angles to the socket support to put the tube in a vertical position. Tuning condensers can be mounted on the sub-panel or "dish" with their shafts extending through to the front. Conversely, neutralizing condensers can be mounted on the front side of the "dish" with their shafts sticking through to

the rear, and since the way is clear here they can be very easily adjusted for a more or less permanent setting. Tubes and plug-in coils can be replaced from the rear with a minimum of effort.

PORTABLE UNITS

Another type of mounting which may prove very popular now that portable equipment is coming into its own is illustrated in Fig. 3. This particular amplifier is intended both for pick-up work in the field and for operation in fixed locations. The notable feature is the design of the mounting brackets, which are fixed in the relay rack at all times. When used in a fixed location, the amplifier is fastened to these brackets by the single screw on either side of the panel at the bottom. For portable use, these two screws are removed, and the amplifier is carried by the handle embedded in the top cover. The protective cover for the front is shown in back of the amplifier in the photograph.

A more common arrangement for portable use is to mount two wooden posts in the carrying case; the equipment is then taken from the rack and fastened to the posts in the same way as to the rack. This should provide a place for portable equipment during the winter months. The portable equipment can have the appearance of the fixed station equipment, and when located on the rack can be operated as conveniently as the fixed station.

CONNECTIONS BETWEEN UNITS

All connections between panels in relay rack construction can be safely located inside the steel channels. A good method is to cable all leads with light twine rubbed thoroughly with paraffin, using half hitches throughout the length of the cable about every half inch all the way up the channel and at every point where a wire or group of wires is taken off to go into a stage. This keeps the leads out of the way so that they will not spoil the neat appearance of the transmitter.

In order that any unit may be quickly removed from the rack for servicing or for portable use, some method must be provided for easily disconnecting all leads from the unit. The leads from the cable may run to a row of Fahnestock clips or to a tube-base plug fitted into a socket mounted on the baseboard near the steel channel. The Fahnestock clips are rather unsatisfactory because if mounted close enough to the iron channel to make the cabled leads short, they are hard to unfasten since there is no space left for the hand. If moved farther out, the cabled leads running along the edge of the baseboard are rather unsightly. The method of using plugs and sockets from the cable to the units is very satisfactory. The amplifier in Fig. 3 has a very neat terminal board on its right side carrying connections for microphone and power. For units not intended to be removed frequently, it would seem that the

connection block illustrated on page 35, *QST* for May 1934, would be admirably suited to the purpose. It is cheap, it can be disconnected in a reasonable amount of time, and is neat in appearance.

SHIELDING

In contrast to the old four-posted rack, shielding on the relay rack is a simple matter. The four-posted rack demanded that each stage be put in its own box and this box mounted on the baseboard holding the stage. When repairs were in order, it was quite a problem to disconnect the wires running into the shield can and remove the can from the shelf. With relay rack construction it is still of course necessary to enclose each stage unless one intends to use a modified form of shielding in the shape of a single baffle plate between stages. A steel front panel can be one side of the shield can; if a wooden panel is used it can be backed with aluminum, steel, or copper. The other five sides of the shield can are then formed by a light metal dust cover. These are available on the market in standard sizes to fit relay racks and are priced very reasonably. This dust cover is mounted on four brackets extending horizontally rearward from the corners of the panel. It is slipped on and off from the rear. It encompasses everything, the above-panel equipment, the sub-panel, and the sub-panel equipment. There is no way for connections to get mixed up. For servicing it is not necessary to tear everything from the rack, since the dust cover can be slipped off and the unit given an inspection without breaking any connections. This is a far cry from some of the four-posted mountings the writer has seen, where it was necessary to break all leads to the oscillator stage and remove the shield can from the shelf just to try a different grid leak.

Since dust covers are cheap and do not in any way complicate construction, they should be very effective for putting that last finishing touch to the transmitter. There is a more practical vein in their adoption, too—the dirt that gathers so effectively on equipment, especially between condenser plates, is excluded.

PANEL LAYOUTS

In laying out a relay-rack mounted transmitter, it will be found that

much panel space can be saved if the radio-frequency stages do not have their panels cluttered up with a lot of meters. The average radio fre-

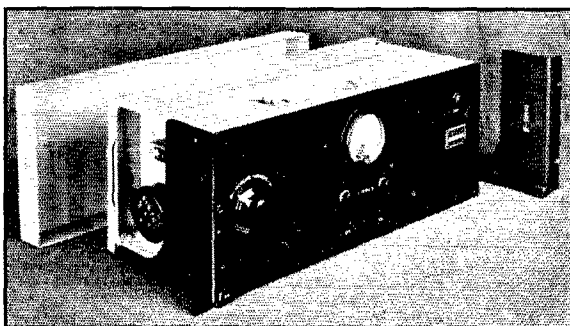

FIG 3—SPECIAL MOUNTING BRACKETS CAN BE USED FOR UNITS INTENDED FOR BOTH PORTABLE AND FIXED SERVICE

In this amplifier, made by Western Electric, the mounting brackets are permanently fixed on the rack. The unit can be removed quickly by taking out the two machine screws which hold the panel in place on the brackets.

quency stage can be very easily run along the 17½ inches of clear space on a two rack-unit panel if meters can be omitted. Some modern construction eliminates all meters from the panels of the amplifying stages and concentrates them in a single meter panel. This does not usually represent any wiring difficulty if the meter panel is located directly below the first radio-frequency stage of the transmitter, with all power supply equipment below it. The leads from the power supplies then pass right by the meter panel in going up to the r.f. stages, and it is a simple matter to tap the leads at the meter panel to read voltages and currents.

Concentration of meters in one panel also offers a definite safety advantage. When tuning a transmitter it often occurs that when one is working on one stage something goes wrong in one of the others. If the meters accompany their respective stages the meters on one panel can bob around and not be noticed. When a meter panel is used, however, the entire transmitter is under observation when anything is touched because all indicators are concentrated in a small area. Any stage can be tuned or adjusted and the reactions on all other stages can be immediately detected without the operator shifting his position. Naturally radio-frequency meters can not be

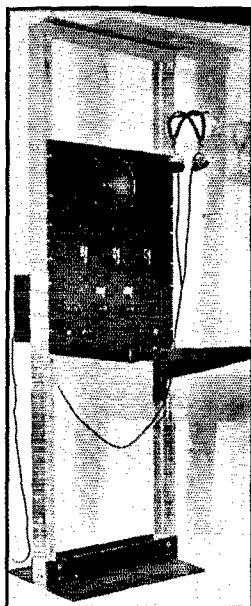

FIG. 4—THE RELAY RACK SERVES AS A NEAT AND EFFECTIVE OPERATING POSITION, AS EVIDENCED BY THIS PHOTOGRAPH OF ONE IN USE AT W2BLL

The desk leaf provides plenty of room for keys and writing materials.

mounted on the meter panel since it would be inconvenient to run heavy radio-frequency leads, and excessive losses would be introduced by their length and proximity to the steel channel. An exception to this can be made in the case of r.f. meters with external thermocouples.

OTHER USES FOR THE RELAY RACK

The relay rack need not be restricted to the transmitter. It makes an admirable operating position, especially when space is at a premium. The rack-mounted operating position of W2BLL is shown in Fig. 4. The desk attachment is a red cedar leaf supported by steel brackets. The receiver was made with a special panel for relay rack mounting. Vibration is so low that it has been quite easy to copy code on the typewriter when it is set on the desk attachment on the rack. The panel above the receiver holds three switches for controlling the transmitter. The upper panel carries the loud-speaker. If desired, another blank panel could be backed with celotex and added above the speaker panel to give a greater baffle. By moving the loud-speaker panel directly below the desk, room would be left on the rack for microphone and speech amplifier stages and for a frequency meter. A mixing panel could also be mounted here if relay work such as described in July 1934 *QST* is to be carried on.

The relay rack also has certain definite disadvantages which might be well worth mentioning. The chief trouble is in the construction of equipment. All panels of the various units must be exactly square, and must be cut to the proper

height within 1/64". This is a rather close tolerance for amateur work, and unless it is adhered to within reasonable limits, there will be trouble in fitting equipment together when it is changed around, and there is danger of unsightly cracks between panels. Relay racks are also heavy. The rack itself is not light, being made of steel, and so much equipment can be concentrated upon it that an entire transmitter, although very small, seems quite fixed. The rack is definitely not for portable use.

The big item of cost in the relay rack is in the machining of the mounting holes. They must be very accurately drilled and tapped or the rack is useless. Slotted relay-rack panels can be purchased at practically the same price as ordinary blank panels. This eliminates all the trouble of squaring up the panels to make them match properly.

The relay rack, then, offers the amateur an effective way of dressing up his station to give it the appearance he desires; and yet it retains sufficient flexibility to adapt itself to change without notice—an essential in all amateur installations.

It might seem at first that the general adoption of relay rack construction would lead to an undesired monotony. The standardization, however, is merely upon physical dimensions; there are so many other variables in amateur work that this should prove an advantage rather than disadvantage. It should give us something constant upon which to base our designs and thereby increase the flexibility of them.

The International Air Race

RADIO amateurs will be given the opportunity to shoot at a world's record for communication with aircraft during the MacRobertson International Air Race from

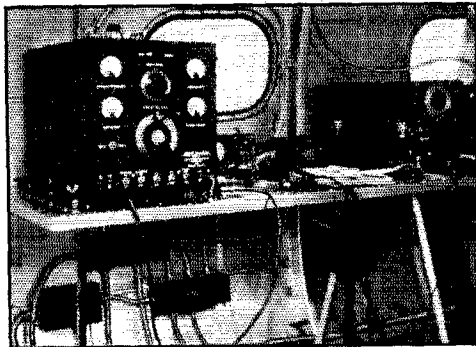

London, England, to Melbourne, Australia, beginning October 20th. Mr. Reeder Nichols will be radio operator on the Boeing 247D to be flown by

Colonel Roscoe Turner and Clyde Pangborn. The radio gear operates on sixteen different frequencies, eight of which are crystal-controlled on high frequencies. The ninth position of a switch mechanism throws in the low-frequency band, which is tunable from 296 to 507 kcs. The c.c. frequencies are 3105, 4140, 5520, 6210, 8280, 11,040, 12,420, 16,560. Low frequencies are 315, 333, 375, 417, 457, 500 kcs. All communications with amateurs will be on either 6210, 8280 or 12,420 kcs. The transmitter delivers 160 watts c.w. into a three-quarter-wave trailing antenna. Operator Nichols plans to listen for United States hams on both the 14- and 7-mc. bands. He will advise in his CQ whether to answer on 7 or 14 mc., depending on which frequency seems the best. Information as to call signal assigned to the plane and further details will be included in addressed messages to amateurs from WIMK and stations of the A.R.R.L. Official Broadcasting Station system. Here is an opportunity for some real DX work with aircraft! Let's make the most of it.

D.C. Measurements With the Ham Station Analyzer

An Auxiliary Unit for Current, Voltage and Resistance Checking

By D. A. Griffin, W2AOE*

IN THE previous article on the Ham Station Analyzer, in June *QST*, a circuit was described which will enable the user to make a variety of radio- and audio-frequency measurements. Direct current and voltage measurements, together with resistance tests, are also necessary if equipment efficiency is to be determined. Trouble shooting and circuit testing are greatly simplified if checks of this type can be quickly made. Except for filament voltages, supply-frequency a.c. measurements are not of much interest, particularly since the regulations require direct current for transmitter power supplies.

The one-mil meter used in the first unit has an ohmmeter scale and a variety of voltage scales. Therefore it is relatively simple to construct an auxiliary unit with suitable resistors and batteries to provide a number of voltage, current and resistance ranges. While meters of higher range, such as 1.5- or 3-mil, can be used, the one-mil meter gives greater sensitivity for the r.f. measurements and, although the higher range instruments cost less, it is false economy to employ them because stock resistors are available for one-mil meters. It is obvious that special resistors for less sensitive instruments would run the total cost up rapidly, more than cancelling the advantage of a lower priced meter.

Accordingly, the unit pictured in Fig. 1 was designed to work in conjunction with the 1-ma. meter mounted in the first unit. An effort was made to provide suitable ranges for general amateur use. Five voltage ranges (from 10 to 2000 volts), five current ranges (from 1 to 500 ma.) and three resistance ranges (0-500 ohms, 0-50,000 ohms and 0-3 megohms) are available. These can be extended to cover special needs, if desired, with little difficulty. Except for resistance measurements, the ranges provided in commercial set analyzers do not as adequately cover amateur requirements.

As pointed out previously, the first "set analyzers" were those using point-to-point tests with a voltmeter and ohmmeter. The true analyzer then followed with a switching arrangement to make a number of tests rapidly merely by rotating a bi-polar switch. A shift back to the old-time methods is now taking place in the broadcast field. This has come about because analyzers have become extremely complex and

costly with the large number of trick tubes now in use. Several modern analyzers are designed for point-to-point work. Testing by this method takes a little longer, but the equipment does not become obsolete because of new tubes and circuit layouts. As amateurs are interested in a wide variety of circuit tests, as well as in simple economical construction, the simple point-to-point method is employed in this unit. Inexpensive pin



THE AUXILIARY UNIT TO THE HAM STATION ANALYZER MOUNTED IN ITS CASE

jacks are used instead of a bi-polar switch, because the cost is lower and also because the switch is likely to break down on high voltages, and varying contact resistance is likely to introduce error.

Inasmuch as the circuit is quite simple, constructional details require little comment. The several resistors for the ohmmeter ranges are first mounted flat against the under side of the panel. The "series shunt" for the current measurements is next mounted close to the pin jacks. All leads in this circuit must be short and heavy because the shunt is a low-resistance affair and any

* Leeds, 45 Vesey St., New York City.

appreciable amount of added resistance will throw off all the current ranges. The resistors used to secure the various voltage ranges are mounted last. Care should be taken to keep them clear of all other wiring to avoid the possibility of break-down when high voltages are measured. "Littelfuses" of suitable size should be inserted at the points marked "X" in the circuit diagram. These inexpensive fuses will save an expensive instrument from burn-out or a costly repair

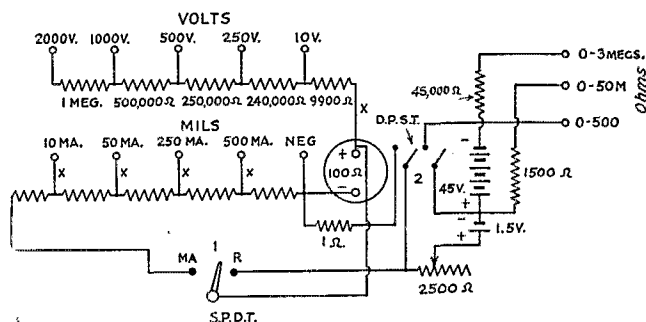

FIG. 1—THE CIRCUIT OF THE D.C. AUXILIARY

"Precision" type resistors are preferable for the voltage multipliers. Resistance values for the current ranges are dependent on the meter used and purchase of a "ring" unit from the meter manufacturer is recommended. Fuses are inserted at the points marked "X," as described in the text.

charge if an accidental overload occurs. The leads connecting unit No. 2 to the milliammeter binding post connections on the first unit should be short and heavy. The test leads used should also be of heavy wire with a good grade of insulation.

To measure voltages, Switch No. 1 must be thrown to position "R" and Switch No. 2 left open. Otherwise the one-ohm shunt and the current shunt will be connected across the meter giving an incorrect reading. The 50,000-ohm and 3-megohm resistance ranges are also used with the switches in these positions. For the 500-ohm range, Switch No. 2 is closed. Switch No. 1 is thrown to the "MA" position and Switch No. 2 is open to make current measurements. The pin jack marked "negative" is common for all measurements, the other test lead being connected to the various jacks to measure voltage, resistance, or current as desired.

With multi-range instruments of this type, the degree of accuracy obtainable is of greatest importance. The cost naturally goes up as the accuracy is increased. However, if we are to have a measuring instrument, it should really measure accurately and not provide a guessing contest. Generally, the moving coil type of meter is accurate to within one or two percent. For satisfactory results, the percentage of error in the resistors must be kept at a small value. This is true because the error in the meter and the resistors may be additive, thus throwing the reading out as much as five percent. The series

resistors for the voltage ranges and the "series shunt" for the current range should be held to a one percent tolerance if possible. This makes the use of high-grade wire-wound resistors necessary. The resistor bank for current measurement is relatively inexpensive as the values of the resistors required are low. The values of resistance are not given because this shunt resistance will vary with different meters. The resistors used for the voltage ranges are fairly costly, however, due to the high resistance required. A fortunate point in favor of those afflicted with slim purses is that these may be purchased on the installment plan, starting with the lowest voltage range and adding ranges as desired. Except for the shunt used to secure the lowest resistance range, which also will vary depending on the internal resistance of the meter, the other resistors do not have to be very accurate because the 2500-ohm variable "zero adjuster" will take care of battery voltage and resistor variations.

The so-called universal meter in which a copper oxide rectifier is used to rectify a.c. current and thus operate a d.c. meter is of little interest to amateurs. The accuracy of these instruments is rarely better than 95%. The calibration may change if the rectifier is overloaded, and the output of the rectifier is not exactly linear. As a 5% error will mean an error of one-half volt on a ten-volt filament, it is evident that this type of meter cannot be compared with a regular a.c. voltmeter. Of course, one of these rectifiers may be interposed between the two units described. Then if an accurate a.c. meter is available to check against, an accurate calibration within one or two percent may be made to cover the usual filament voltage ranges.

With the combined instruments, practically all measurements and tests necessary to secure high operating efficiency of both receivers and transmitters may be made.

As the writer does not want to be a party to the demise of some QRM producer, it might be well to point out in closing that a 2000-volt jolt from a meter can be just as disastrous as one from a power supply—with the further disadvantage that it can be reached easily. In making high voltage tests, therefore, it is a good idea to treat the meter as a hungry lion with laryngitis. It won't roar but oh! what a bite.

NOTE: In connection with the Ham Station Analyzer described in the June issue, the author points out that the 1½-volt filament battery, of Fig. 1 on page 31 of that article, should have its positive connected to the upper end of resistor R_1 instead of to the "ground" end. Otherwise R_1 is in series with the filament supply when a plug is inserted in J_1 .—EDITOR.

With the Affiliated Clubs

WELCOME is extended to the following amateur radio societies newly affiliated with the A.R.R.L., as of September 26, 1934:

Down River Radio Club, Wyandotte, Michigan.

Indianapolis Radio Operators Club, Beech Grove, Indiana.

Island Radio Club, Bar Harbor, Maine.

Minneapolis Radio Club, Minneapolis, Minnesota.

Missoula Radio Operators Club, Missoula, Montana.

St. Petersburg Amateur Radio Club, St. Petersburg, Florida.

A current misunderstanding has been brought to our attention relative to the A.R.R.L. Board's new ruling concerning club affiliation. It is not necessary that 60% of all club members be members of the A.R.R.L. before the club may be affiliated. The correct version is that 60% of the licensed amateur members of a club must be A.R.R.L. members, and that the control of club affairs must be vested in the licensed amateur members. Just as the Board moved to permit voting in A.R.R.L. director elections only by licensed amateur members of the League, it also wished to assure that the policies of the League's affiliated clubs be decided by licensed amateurs. While necessitating slight changes in the by-laws of some clubs, this should in no way affect the practical operation of any club.

Beaver Valley A.R.C. Hamfest

The Beaver Valley Amateur Radio Club of Rochester, Pa., announces what it hopes to be the largest hamfest ever held in Western Pennsylvania. It will be the Third Anniversary Party of the club. The date: October 27th. The place: Saxon Hall, Sixth Street, Monaca, Pa.

The Ponca City Key Clickers Club

Several years ago a group of enthusiastic amateurs in Ponca City, Okla., got together and built a brick shack for their club. The bricks were junk fire brick discarded by a local refinery and were laid by the hams. The Ponca City Key Clickers have grown and now have a licensed station, W5LR. Thursday night is club night and W5LR is on the air, c.c. on 3780-kcs., from 7:30 to 8:20 p.m. and from 9:00 to 10:00 p.m., or later. Dues are thirty cents per month. The club furnishes each member a free membership in the A.R.R.L. Memberships are given only at one period during the year and new members coming into the club after that time do not get their

membership until the next time fees are sent in. If a member has not paid as much as two dollars prior to that time in club dues, he must pay the difference between two dollars and the amount he has paid the club, whereupon he is entitled



HOME OF THE WEST ESSEX RADIO CLUB, INC.—
W2HMK

to the A.R.R.L. membership. This may offer a suggestion to other clubs. The Ponca City Key Clickers staged a successful Oklahoma State Convention last January, and plan to sponsor another in the summer of 1935.

West Essex Radio Club, Inc.

The West Essex Radio Club, Inc., of Verona, N. J., was organized January 3, 1934 with four-



CANADIAN GENERAL
MANAGER REID, VE2BE,
SNAPPED AT THE
OTTAWA PICNIC ON
LABOR DAY

teen active hams as a nucleus. Meetings at the start were held at the homes of the various members. Later, through the generosity of the Borough of Verona, the club was given the use of a room in the Borough Hall. This was not entirely satisfactory due to other organizations using the same room so a search was started for a more suitable meeting place. A very neat cottage was finally located and secured at a rental to meet the club budget.

This cottage has filled the bill splendidly and a club transmitter has been installed under the call W2HMK. Membership is increasing regularly. 56 mc. is found very useful in transmitting club meeting proceedings to

(Continued on page 80)

H A M D O M



THE colorful radio career of Captain R. B. Woolverton, Liaison Officer of the 9th C.A., A.A.R.S., began in 1904, when, as Chief Radio Electrician, U. S. N. he made several world's DX records. In 1905 he invented a high-frequency spark to combat static and interference, the priority of which has been sustained in later court decisions. After Harvard, 1908-12, he continued



his career as research engineer with National Electric Signaling Co., as U. S. Radio Supervisor for the 6th and 7th districts between 1912 and 1915, and then with Federal Telegraph until the War. He has remained in the Army since that time, on active duty in the Signal Corps since 1920. In 1929 he took charge of

the A.A.R.S. in the 9th C.A., since then operating W6PQ/W6ZG/WLV. He thinks the 9th C.A. crowd the best group of radio amateurs in the world, and what they think of him is shown by the fact that they recently petitioned Washington for a second extension of his tour of duty as their mentor and leader.

WHEN 11-year-old Ed Lewis inveigled his father into Wm. B. Duck's radio store in Toledo that summer morning in 1921 to price radio gear, it developed that it ought to be possible to put up a fairly decent outfit for about \$500. Perhaps needless to say, they left the store empty-handed, and young Lewis began his radio career with a telegraph key and buzzer. He's gone a long way since that time, though, for his is the chief responsibility for the success of the Elmira gang in handling communications for the past three or four National Gliding and Soaring meets. In his spare time, he works for American Airlines at the Elmira, N. Y., airport as radio dispatcher. He also dispatches ham signals from an 852 at W8ACQ. With winter coming on, you'll probably find him polishing off Mozart's tenth sonata as it



should be polished off, or trying to convert Dr. Langmuir into Hamdom. It won't be until the Sixth Annual Soaring Meet next summer, though, that he'll really get going again.

ANOTHER man with a consistent record on the air is E. F. Henning, W5BBI, of Little Rock, Ark. He has averaged 10 QSO's per day since getting on the air in 1930. The longest lapse was his visit to W9USA and A Century of Progress in 1933. In the A.A.R.S. his call is WLUA, and he is first alternate 7th C.A. net control station and assistant to the 7th C.A. Radio Aide. He was declared the outstanding member of the A.A.R.S. for the 1931-32



season, winning every Army-Amateur contest and leading the entire U. S. in high scoring. An extra 1st class operator, charter member of the A-1 operators club, his walls are plastered with certificates, including WAC, ORS, RM, Public Service, A.A.R.S. Red Hot, and 1931 frequency accuracy certificate. Just to round out the story, it might be added that his hobbies, besides ham radio, are ham radio, and ham radio.

VERSATILITY is the keyword at W3BWT, a station which is outstanding in traffic, 'phone, and DX. The operator is Eppa W. Darne, and he started in amateur radio in 1911, at the age of 9. He was one of the first to build and operate a successful 100-meter transmitter. He maintained a regular schedule with W8EU for seven years. He has made the call W3BWT and Washington synonymous in traffic circles. He operates as Alternate Net Control

for WLM, using the call WLMB. He did a big job for the National Geographic Society in copying nightly dispatches from the Haardt Trans-Asia Expedition. He participates in every contest and important activity, as well as maintaining almost daily contacts and schedules.





Battery Receiver Using a Type 19 Tube

In an endeavor to develop a light and fairly compact receiver which could be used both at home and in the high-school laboratory, a series of tests using a Type 19 tube was carried out. Although a number of circuit arrangements was tried, not all the possibilities of the tube may have

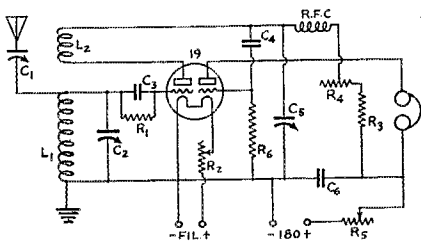

FIG. 1—RECEIVER USING THE TYPE 19 TUBE AS COMBINED DETECTOR AND AUDIO AMPLIFIER

- C₁—15- μ fd. midget variable.
- C₂—100- μ fd. variable.
- C₃—100- μ fd. fixed condenser.
- C₄—0.004 μ fd.
- C₅—350- μ fd. variable (regeneration control).
- C₆—0.1 μ fd.
- R₁—2 megohms.
- R₂—Bradleyohm filament control (10-ohm rheostat may be used).
- R₃—3500 ohms, 1 watt.
- R₄, R₅—High-resistance Bradleyohm.
- L₁, L₂—See text.

been brought out; still the results showed very definite improvement over several 19 sets the writer has previously seen described, both in the use of fewer parts and in increased volume.

In the finished receiver, a diagram of which is given in Fig. 1, one section of the tube is used as a regenerative detector and the other as a resistance-coupled amplifier. The set itself was largely made from old receiver parts, and is built into a cigar box measuring 3½ by 6 by 12 inches, the inside of which is fitted with a shield of No. 12 gauge aluminum. The bottom of the box is used as the front panel of the set.

The circuit values given in Fig. 1 were arrived at after considerable experimenting. Although some of them are not particularly critical, the value which gave best results is specified in each case. Transformer coupling between the detector and audio stage was tried, but did not give as good signal strength as the resistance coupling shown.

The plate load for the detector consists of the

resistors R_3 and R_4 . The latter is variable, and once set at the point giving maximum signal strength may be left alone. A single 50,000-ohm fixed resistor may be substituted for R_3 and R_4 with good results. Resistor R_5 is not strictly essential, since its purpose is simply to regulate the "B" supply voltage in case it is more than 135 volts.

The detector coils, L_1 - L_2 , are similar to those used with other regenerative detectors. It is a good plan to make up a dozen or so on old tube bases, using windings of various turns ratios between L_1 and L_2 , and ranging from perhaps 5-4 up to 50-12 turns, using No. 26 or No. 28 enameled wire. The coil which gives the best signal strength and smoothest regeneration on each band then can be selected.

—Charles W. Clifford, W6KFE

Power Transformers in Series

Several fellows have written in to suggest using the outputs of two low-voltage transformer-rectifiers in series as an economical means of getting plate voltage of the order of 750 to 1100 volts. Since inexpensive transformers and recti-

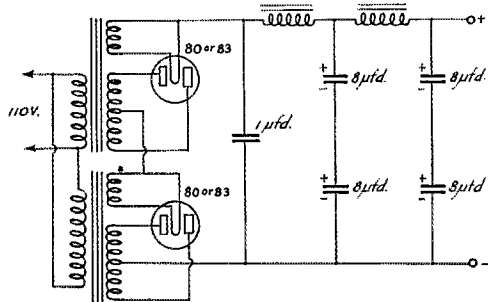

FIG. 2—TRANSFORMERS AND RECTIFIERS IN SERIES FOR HIGH VOLTAGE

The circuit arrangement shown above gives pure d.c. from a 25-cycle supply line. Less filter would be required with 60-cycle supply. The filter chokes are the ordinary type rated at 20 to 30 henrys.

fiers can be used, the system represents quite a saving as compared to the cost of a high-voltage transformer and the 866 rectifiers ordinarily required. The filter is designed as though it were to be used with a regular high-voltage transformer and rectifier.

A typical system of this kind is the one used by W. K. Schafer, W9BCA, shown in Fig. 2. This

particular power supply delivers about 600 volts under load, using a pair of 300-volt broadcast-type transformers. Since W9BCA's power-line frequency is 25 cycles, somewhat more filter is shown than would be needed for 60-cycle supply. On the latter frequency a simple brute force filter would suffice.

Type 80, 82 or 83 rectifiers may be used without danger of tube breakdown with transformers giving up to 550 volts each side of the center tap. There is no reason, in fact, why more than two transformer-rectifiers could not be connected in series. The current that can be taken from the system is the same as for one transformer, however, so that the scheme is limited to 150 ma. output with transformers of ordinary ratings.

Coupling a 57 S.A. to a P.P. Amplifier

In the Experimenters' Section in September *QST*, W9JHY mentions the difficulty of getting a coupling device suitable for coupling the plate circuit of a 57 speech amplifier to a following push-pull amplifier. Fig. 3 shows a method that has worked beautifully for me, making it possible to drive a pair of push-pull 45's from a single-ended 57. The 45's act as drivers for four 46's in push-pull parallel, Class B.

The audio choke in the plate circuit of the 57 should be center-tapped and should have an inductance of 600 or 700 henrys. If such a choke is not available, the secondary winding of a good

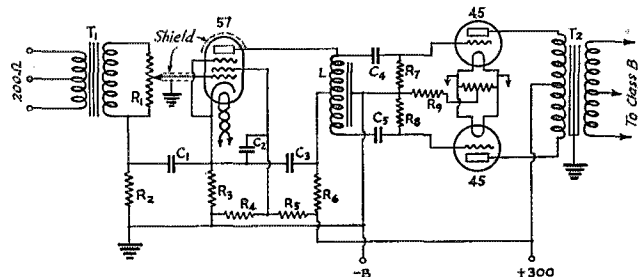

FIG. 3—SPEECH AMPLIFIER USING SPLIT-CHOKE COUPLING BETWEEN A 57 AND PUSH-PULL 45'S

L—600-henry tapped choke.
*C*₁—6 μfd.
*C*₂, *C*₃—2 μfd.
*C*₄, *C*₅—0.1 μfd.
*R*₁—Gain control, 500,000-ohm potentiometer
*R*₂—250,000 ohms.

*R*₃—1000 ohms.
*R*₄—12,000 ohms.
*R*₅, *R*₆—50,000 ohms.
*R*₇, *R*₈—500,000 ohms.
*R*₉—750 ohms.
*T*₁—Microphone transformer.
*T*₂—Class-B input transformer.

push-pull input transformer can be used. The choke here was salvaged from a b.c. receiver, where it had been used to couple a screen-grid detector to a couple of 45's in push-pull. It is important that the inductance of the choke be as high as possible.

Aside from the coupling arrangement, the remainder of the diagram is more or less standard.

—Roy Usher, VE4EA

Separate Regeneration in Multi-Purpose Tube

The idea of using a separate tube to furnish regeneration in detector circuits—a system which permits separation of the functions of oscillation

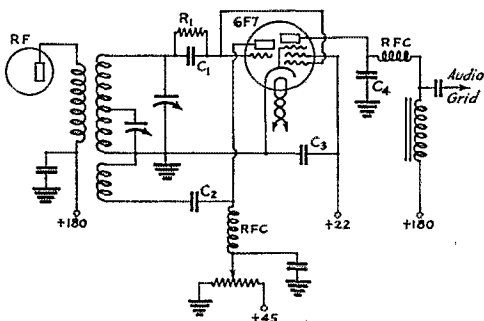

FIG. 4—SEPARATE DETECTOR-OSCILLATOR, WITH 6F7 TUBE, USING THE SAME TUNED CIRCUIT

Circuit constants will be the same as with ordinary regenerative-detector arrangements. Grid condenser, *C*₁, is 100 μfd., and grid leak, *R*₁, 5 megohms. *C*₃ is the blocking condenser for the oscillator portion of the tube; its value may be .0005 to .002 μfd. Since parallel feed is used in the oscillator circuit, the r.f. choke going to the triode plate must be effective over the range of frequencies covered by the receiver. W4BBX uses a National Type 100. *C*₄ is the usual plate bypass condenser having a capacity of 100 to 250 μfd. The screen bypass, *C*₅, should be 0.5 to 1 μfd.

and detection—has been revived by D. C. Ketcham, W4BBX, and applied to one of the newest of the multi-element tubes, the 6F7. The 6F7 is a double tube, having a triode and r.f. pentode in one bulb. W4BBX writes as follows regarding the circuit:

"Fig. 4 shows some changes I have made in my receiver, which is patterned after the National SW3, to use a Type 6F7 tube as a detector and heterodyne oscillator. This scheme using a screen-grid detector and a separate triode as the oscillator has appeared in past issues of *QST*, but with comment which appears half-hearted in view of the tremendous improvement it makes in the operation of the receiver. The only factor which I have found critical at all is the detector screen voltage, which should be about 22½ volts for best operation. With a variable voltage divider this presents small difficulty because the tremendous increase in volume makes it readily apparent when the optimum voltage is reached. It is an easy matter to rig up a 6-volt winding for the heater supply and separate the detector heater from the r.f. and audio tubes in case 2.5-volt tubes are used in the receiver.

"It will be noted in the diagram that to avoid

the use of the separate grid connection on the band spread coils I have changed the tickler to shunt feed. In some cases it may be necessary to add a few turns to the tickler winding, but as it is no longer a case of a compromise between an oscillator and detector this makes no difference.

"As an economy measure I have mounted on the panel a midget 100- μ fd. variable condenser permanently connected across the grid coil, and use another of the same size for the antenna trimmer. The former serves in place of the small mica trimmers, giving air dielectric performance on all bands, and also allows the tapped band spread coils to be used for general coverage with band spread at any point."

Disabling the Receiver During Transmitting Periods

The writer's station, W9BHM, operates on both c.w. and 'phone, and since the receiving antenna is within the field of the transmitting antenna, it has always been necessary to turn the volume control on the receiver to minimum position during each period of transmission, to eliminate feed-back between the microphone and speaker when using 'phone, and to reduce the "machine-gun" racket in the headphones when using c.w. Even with the volume control in the minimum position, there seemed to be a slight reaction on the second detector, which caused a squealing sound in the headphones with the carrier on the air.

The circuit diagram of Fig. 5 shows the simple changes that were made in the receiver to overcome these difficulties. Volume is controlled in this receiver by a variation of cathode (grid bias) voltage applied to the r.f. and two i.f. stages. One end of the volume-control potentiometer was

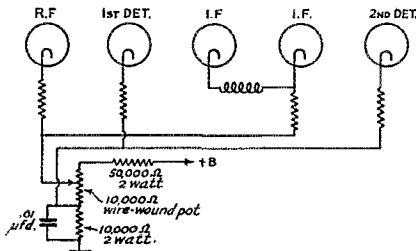

FIG. 5—RECEIVER DISABLING CIRCUIT

The system applies particularly to superhet receivers in which the volume is controlled by grid-bias variation.

originally grounded to the chassis and negative "B." With the volume control in the minimum position 50 volts negative is applied to the r.f. and i.f. grids, completely blocking reception of signals. Checking with an 0-10 milliammeter in the plate supply lead to the r.f. tube showed that the plate current was zero with the volume control at minimum position, but with the carrier on the air

the milliammeter registered three or four milliamperes. It was found this could be eliminated by simply grounding the antenna binding post on the receiver during periods of transmission.

To accomplish the same result produced by turning the volume control to minimum and grounding the antenna in one simple operation, the ground connection to the volume control was removed and a 2-watt 10,000-ohm resistor (R) connected as shown. A binding post was mounted on and insulated from the chassis, and a connection made between this binding post and the ungrounded side of the new 10,000-ohm resistor.

On the operating desk, a 4 P.D.T. anti-capacity switch was already in service, two of the contacts being used to close the 110-volt circuit to the relay coil, the contacts of which in turn close the 110-volt circuit to all plate voltage supply transformers. Two of the remaining unused switch contacts were connected from receiving antenna to ground, the contacts being closed with switch in transmitting position. Another set of two contacts, which are open with the switch in the transmitting position, are connected from ground to the insulated binding post on the chassis.

With the anti-capacity switch in the transmitting position, the receiver becomes completely dead even though tuned to the transmitter frequency because (1) the receiving antenna is grounded; (2) an additional 50 volts bias is applied to the grids of the r.f. first detector, both i.f. and second detector tubes. At the instant the transmitter carrier is removed, the receiver becomes operative and at the same volume.

—L. B. Wilcox, W9BHM

Carrier Ratings with Suppressor-Grid Modulation

WE'D be the last to deny that pentode power tubes have many points of superiority over types with fewer elements—*QST* instigated the production of the RK-20, the first of what probably will soon be a good-sized family—but the year 1934 has not seen any 'phone miracles. It's still true, to be specific, that for 100% modulation additional sideband power to the extent of 50% of the unmodulated carrier power must be supplied. When the extra power is not furnished by a modulator, it's got to come from the r.f. tube, and the only way it can be obtained is by cutting down the carrier power until the necessary reserve is there to take care of the modulation.

In some quarters there has recently been a tendency to rate RK-20 transmitters at the same power for both c.w. and suppressor-grid 'phone, or at least the information has been presented in such a way as to lead the uninformed reader to believe that the carrier power is the same in both cases. It just doesn't work that way. If the trans-

(Continued on page 70)

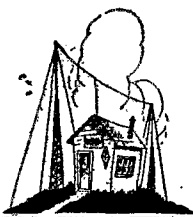

Amateur Radio STATIONS



W3KL, Bridgeton, N. J.

IF THE view of the transmitter at W3KL in the accompanying photographs makes it appear to be a formidable outfit, the receiving equipment is hardly less so, being relay-rack mounted and evidently of largish proportions. W3KL, the property of Arthur C. Whitaker, Jr., O.D., and located in Bridgeton, N. J., is a 160-meter 'phone station—or rather, a 160-meter transmitter with receiving carried on in both the 160- and 75-meter 'phone bands.

The transmitting equipment, including power supplies, r.f. circuits, speech amplifiers and modulator, is all mounted on the single frame. The high-voltage power supply, consisting of a 6000-volt center-tapped transformer, 872-A rectifiers, heavy swinging choke and the usual filter, occupies the lower section of the frame. With it there is also a low-voltage supply which takes care of the filament and plate requirements of the third speech amplifier, a power tube. The r.f. part of the transmitter consists of a 552 master oscillator

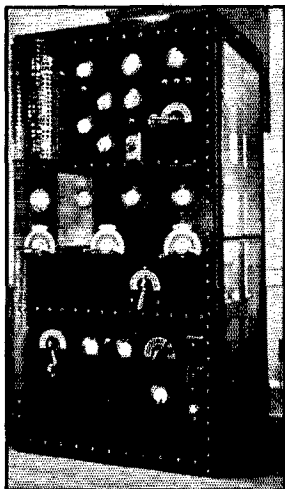

THE TRANSMITTER AT W3KL

driving a pair of 552's in parallel as a Class-C amplifier. The dropping resistor and by-pass condenser for Class-A modulation are also located here, together with the modulation choke, a special 45-henry, 600-mil job.

The top section is taken up by speech amplifiers and modulator. The first tube after the microphone transformer is a 27, followed by a 56 second stage and a 10 third stage. The latter tube drives a 549 Class-A modulator. Transformer coupling is used throughout. The 549, incidentally, is mounted on the front of the panel and enclosed in the "cage" at the upper left. The input to the modulated stage is 250 watts, fully modulated. A full complement of voltmeters and milliammeters makes continuous monitoring of plate voltages and currents on all stages possible.

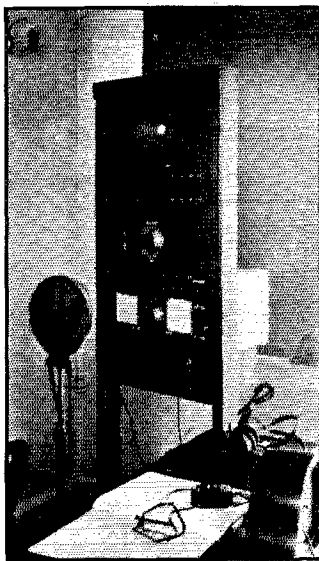

W3KL

The receiving panel contains a National AGSX receiver, loud speaker, and switches and a wave-trap panel to make duplex work possible on either 160 or 75 meters. The transmitter is tuned to 1805 kc., and from that frequency duplex operation can be carried on in three-quarters of the 160-meter 'phone band, as well as on all the 75-meter band. The antenna is a simple inverted-L type, 132 feet long, working against ground. The microphone is a Universal

double-button type LL.

W3KL is located in a separate one-room house of its own, with all wiring concealed under the floor or in the walls. Cables and outlets are shielded. Heating is taken care of by pipes running underground from the heating plant in Dr. Whitaker's residence.

W5DLG, Tularosa, N. M.

W5DLG is a neat example of what might be called the typical amateur c.w. station—a fairly low-power transmitter using a pair of 10's

in the output stage, a tuned-r.f. regenerative-detector receiver, and a monitor. The rig is owned by A. P. Sitton, Jr., of Tularosa, N. M.

The transmitter, at the left in the photograph, is crystal controlled, with a 47 oscillator, 46 buffer and a pair of 10's in parallel in the final amplifier. It is used on the 3.5- and 7-mc. bands, with a separate crystal for each band. Two power supplies are used, a 300-volt supply for the oscillator and a 550-volt supply for the last two stages, the voltage being dropped to 400 volts for the buffer tube. The transmitter is built in three sections, the lower one (with the meters) containing the power supply, the middle one the oscillator and buffer, and the top (which goes out of the photo) the final amplifier. Each section is a separate unit and can be slipped out the front like a drawer, making alterations and repairs easy.

The monitor is just to the right of the transmitter. It is battery operated and uses a Type 30 tube. The tuning range is such that both the 7- and 3.5-mc. bands are covered with one coil. The home-built receiver which appears in the picture, a detector-audio set using two-volt tubes, has now been replaced by a National ACSW-3. The small control panel to the right of the receiver switches the transmitter on and off and reverses the procedure for the receiver.

Although W5DLG has been on the air only a short time, all districts except the third have been worked on 80 meters.

W3BWQ, Wyncote, Penna.

THE accompanying photograph of W3BWQ should suggest some ideas to those hams who find themselves limited to a few square feet of floor space in a room which the OW will not permit being littered with the collection of apparatus which constitutes the usual amateur station. William J. McLaughlin, Jr., of Wyncote, Pa., is the owner of W3BWQ. It looks as though he has done a good job of compressing a fairly high-power station into a small space.

The framework supporting the station is made of hardwood, and is constructed in the form of a writing desk to harmonize with the other furniture in the room and to provide an operating

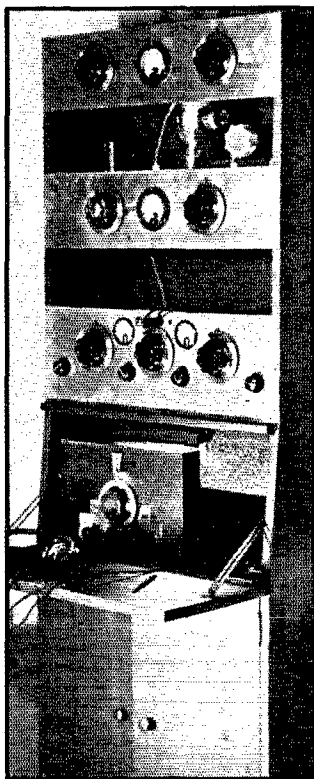

W3BWQ

table which can be folded up out of the way. The shelves in the upper part of the desk, which normally would be reserved for books in similar pieces of furniture, are occupied by the r.f. portion of the transmitter. The 47 crystal oscillator, 46 buffer-doubler, and 10 second buffer stages are mounted on the lower shelf behind an aluminum panel. The 852 final amplifier, link-coupled to the 10, is on the upper shelf, behind two similar panels on which are mounted the tank and antenna-tuning controls. The transmitter operates on the 3.5-, 7- and 14-mc. bands, using both 3.5- and 7-mc. crystals.

The receiver is a Ross Jupiter superhet. Its compactness makes it well suited to the limited space on the writing shelf. The loud speaker is fastened to the under side of the shelf above to leave space for the key and control switches. A desk light is above the receiver.

Power supplies are contained in the space below the writing shelf, concealed by folding doors which keep the operator out of danger from high voltages. Three plate supplies are used, one giving 450 volts for the os-

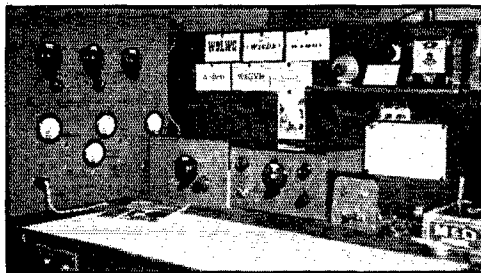

W5DLG

illator and buffer-doubler, a second giving 750 volts for the 10 buffer, and the third giving 2000 volts for the 852. A 300-volt supply is used to bias the 10 and 852.

Strays

Logs *must* be kept these days. W1FGC, out with a party for some portable 5-meter work, arrived on location minus pencils. A quick substitute was found when the YL with the party volunteered some rouge, which, with a toothpick and a little water, provided pen-and-ink.

• I. A. R. U. NEWS •

Devoted to the interests and activities of the

INTERNATIONAL AMATEUR RADIO UNION

President: H. P. MAXIM

Vice-President: C. H. STEWART

Secretary: K. B. WARNER

Headquarters Society: THE AMERICAN RADIO RELAY LEAGUE, West Hartford, Conn.

MEMBER SOCIETIES

American Radio Relay League
 Associazione Radiotecnica Italiana
 Canadian Section, A.R.R.L.
 Československý Amatérský Vysílač
 Deutscher Amateur Sende-und-Empfangs
 Dienst
 Experimenterende Danske Radioamatører
 Irish Radio Transmitters Society
 Liga Columbiana de Radio Aficionados

Liga Mexicana de Radio Experimentadores
 Nederlandsche Vereeniging voor Internationaal Radioamateurisme
 Nederlandsch-Indische Vereeniging Voor
 Internationaal Radioamateurisme
 New Zealand Association of Radio Transmitters
 Norsk Radio Relé Liga
 Polski Związek Krotkofalowców
 Radio Society of Great Britain

Rede dos Emissores Portugueses
 Réseau Belge
 Réseau des Emetteurs Français
 South African Radio Relay League
 Suomen Radioamatööriliitto r.y.
 Sveriges Sändareamatör
 Unión de Radioemisores Españoles
 Union Schwel's Kurzwellen Amateur
 Wireless Institute of Australia

Conducted by Clinton B. DeSoto

Map:

At the bottom of the next page there appears a map of the world. This map is divided into six different areas—the six continental areas of the world. The purpose of the map is to provide an official classification of all the regions of the earth in connection with the issuance of WAC certificates.

This map is the result of a great deal of thought and tribulation on the part of I.A.R.U. headquarters, and careful consideration and suggestion on the part of the various member-societies. For a number of years it has been apparent that a "Final Authority" should be caused to arise in international circles to settle once and for all just what places were where in working WAC. About three years ago we began the preparation of a list of countries of the world, dividing them into six groups, to accomplish such classification. This project even progressed to the point of being submitted to the member-societies for consideration. The scheme was shown to be unworkable, however, for several reasons.

The only workable solution proved to be an official map of the world, the sort of map we now have. It has been created by, and is approved by, the I.A.R.U. It combines the majority opinion of the leading geographers, having taken both geographical and political boundaries and discrete areas into consideration, as well as the peculiar problems of amateur radio. It seems to us to be nearly ideal for the purposes and to solve the problem for which it was designed.

The map itself is self-explanatory. Any place located within a designated area is a part of that "continent," whether it be island or mainland. Moot points where small islands fall very near

to boundary lines can be settled by inquiry of any member-society headquarters, where reference to a detailed master copy of the map will settle any question.

And now, you would-be WAC men, you know just what is what. Have you worked Asia? Have you worked Africa? The map will tell.

Regulations:

The following information can be added to that contained in the article on the amateur regulations of the world in the August issue:

All the Madrid bands are allowed in France. The maximum power input is 100 watts, exceptionally 200. Pure d.c. is required. The license fees are 50 fr. per year for operator's; for station, 100 fr. for 50 watts, 150 for 100 watts. Third party traffic is not permitted. There are about 700 licensed stations.

The full 3.5-, 7-, 14- and 28-mc. bands are open in Denmark, and a spot frequency of 1970 kc. is assigned in the 1.7-mc. band. Telephony is permitted on all bands, as in France. The operator and station licenses are combined; the fee is 20 Kr. annually. The E.D.R. is permitted to give a code test, which is accepted by the government. The maximum input is 100 watts. Communications concerning tests and conversations on technical subjects only are allowed; no messages can be handled for third persons. There are approximately 125 licensed stations.

In Australia all bands are open without restriction, and in addition there is a special amateur broadcasting band between 175 and 200 meters, available outside of general B.C. hours, allotted by the W.I.A. to its members for experimental telephony. The maximum power input is 25 watts. The operator's license fee is 5/-, the sta-

tion license 30/-. Third party traffic is not permitted.

Armistice:

The *Reseau des Emetteurs Francais* again invites the radio amateurs of the world to observe with them the anniversary of Armistice Day, November 11, 1918. Last year, it will be recalled, an inspiring ceremony was observed. At precisely 1100 G.T. every station on the air in France and a number in foreign countries allowed their transmitters to run with full carrier power, unkeyed and unmodulated, for one minute. This impressive observation of the minute of silence traditionally spent in homage for the heroes of the war is again to be carried out this year. The R.E.F. requests every amateur to stop transmitting at exactly 1100 G.T., holding the key down but not sending code or speaking into the microphone. From hundreds of other amateur stations the same ceremony will be observed, and from their antennas the "silent" carriers will be transmitted, indicating the silent presence of the amateurs at their posts.

Amateurs in all countries are asked to collaborate with their French comrades in making this same gesture, and in uniting with them in thought.

QSL:

K6HLP writes to W6JXG-W6KNM that about half the cards he gets from the States have 2- or 3-cent stamps on them. One cent postage

is enough. There's no need to waste QSL money that way, OM's. Refer to the list of postage rates of the world beginning on page 42 of the June 1932 issue of *QST*. If you haven't that list, W6JXG will be glad to send an abbreviated list upon receipt of a 2-cent stamp.

The S.A.R.R.L. reports the "misuse" of four calls. In this country, we'd call it out-and-out bootlegging, in the case of two of the calls, at least. The calls are as follows: ZU1C (who actually works on nothing but 56 mc.; 300 cards have been received; a European pirate is suspected), ZS1W, ZS1ESA, and ZS1K. A report on any observations made while working stations signing these calls will be appreciated.

Generals

The *Reseau Belge* is already making plans for the International World's Fair to be held in Brussels next year A large station will operate on all bands, and a number of general meetings are contemplated Of 1000 volunteers volunteering for radio work in the Arctic in the U.S.S.R. 200 were hams, characterized as the best radio men of the Union on the short waves Six were chosen to man the three polar stations to be organized before the end of the year The latest YL to WAC is Miss Barbara Dunn, G6YL, Acton House, Felton, Northumberland, England Many dozens of American amateurs

(Continued on page 76)

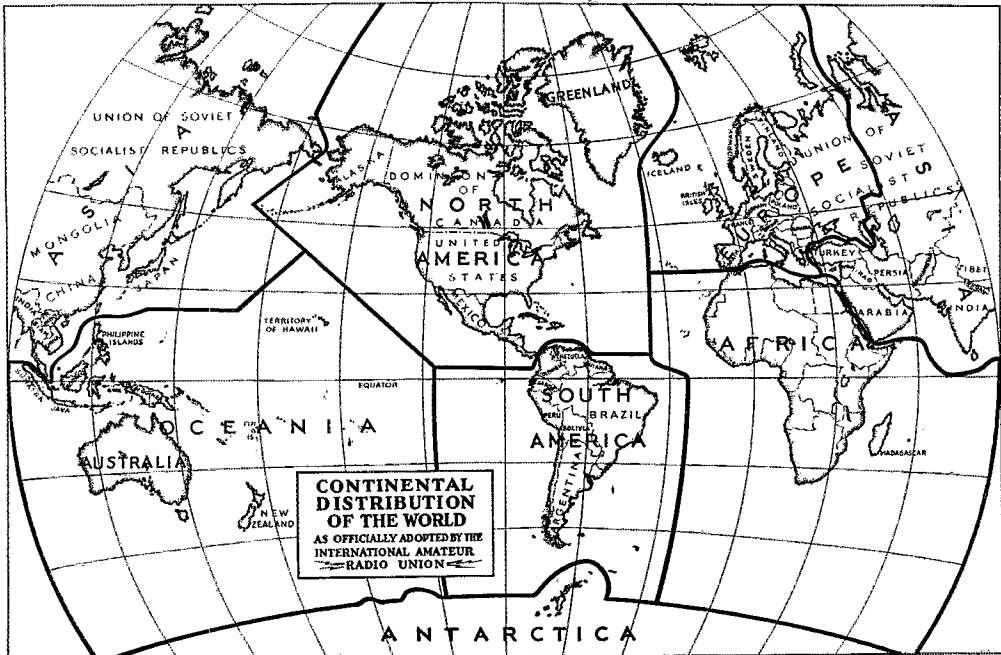



OPERATING NEWS



Conducted by the Communications Department

F. E. Handy, Communications Manager

E. L. Battey, Asst. Communications Manager

PLEASE give the R-S-T system, presented by W2BSR last month, a thorough test. For your convenience a chart covering the new R-S-T definitions in full, in such form it can be clipped out to put in your operating room, is given on page 72 of this issue of *QST*. As mentioned in October, before any system is adopted as standard practice it must successfully meet the acid test of practical use. The simplicity, lack of confusion in definitions, and the completeness combined with brevity in the R-S-T plan have a strong appeal to operators who value these qualities. The new system has been warmly welcomed by the majority of amateurs, judging from correspondence on the subject. SCMs and RMs have written to endorse it or have immediately put the new system to work, with few exceptions. Try it out, and after a fair test for a week or more let us have your opinion and suggestions. Do you or do you not find the system useful?

WX Reports by Radio

A radio weather reporting system has been inaugurated by the A.A.R.S. in the fifth district. The idea started with the gang at W5OW, Fort Sam Houston, Texas. Seven Oklahoma amateurs make observations each day: W5CEZ, W5AMT, W5BAR, W5BJG, W5BKK, W5BQZ, W5DTC. W5CEZ collects the reports from the other six between 6:15 and 6:45 a.m. daily and sends them, together with his own observations, to W5OW at 7:00 a.m. The information is then put out to all the Air Corps in that Corps Area, and is also given to the Department of Commerce station in San Antonio. W5OW also collects observations from several Texas stations (calls unknown at this writing).

N.C.R. Exhibit at Yuba-Sutter Fair

N6GUK was installed and manned by members of the Naval Communication Reserve in cooperation with the California National Guard at the Yuba-Sutter Counties Fair, Marysville, Calif., August 23rd-26th. By using old lumber and painting it, and securing cooperation of other exhibitors, the cost of the booth to house the station was kept below five dollars. This included cost of antenna wire and insulators. The color scheme was black and aluminum with crepe paper background in Navy blue and white. The exhibit was advertised from the booth over 1.75-mc. 'phone, being picked up on an all-wave receiver near the P.A. system and broadcast to the crowds. The exhibit drew the largest crowd of any single exhibit, the fifteen-foot isle in front at times being packed to capacity. The National Guard gang put on a 56-mc. demonstration, placing a set in a car, which drove around town picking it up at the fair and re-broadcasting it over the P.A. system. 130 messages were

handled from N6GUK. Schedules were maintained with W7CFM, Eugene, Oregon. His assistance and that of W6HAG, San Fernando, was very valuable in moving traffic. The National Guard 56-mc. gear operated under call W6LAD. N.C.R. cooperation in the exhibit was under the direction of Section 5, Twelfth Naval District. The 12th Naval District has won the national N.C.R. competition for three consecutive years, and Section Five has won high score in the District for the same period.

The Mid-East Regatta

An important part in the program of the seventh annual Mid-east Regatta held in Marietta, Ohio, August 24th and 25th, was that played by the members of the Marietta Amateur Radio Society. This was the installation and operation of four complete amateur stations for communicating between the different officials and judges of the race committee. In boat races of this kind it is necessary that judges be located at both ends of the course as well as on the official barge, at the starting gun. Communication between these various points is absolutely essential. Here is where amateur radio and the Marietta Amateur Radio Society came in. The trial run, held about a week before the races, proved that everything was in readiness.

Came the opening day. At 8:00 a.m. every operator and assistant operator reported for duty. At 10:00 a.m. every man was at his post. Traffic began to move and continued to move until 6:00 p.m., when the final race was over for that day. The next day, Saturday, was the same. Everything clicked perfectly and the whole system was flawless. Phone was used exclusively. W8VZ, operated by Carl J. Anderson and Roy Schradder, was the key station, operating on 3935 kc. From this station, contact could be made with any of the other stations, as all had their receivers tuned to this frequency. W8VZ's transmitter employed a single '10 in the final, modulated by one 250. W8KYC, regular club station, operated by Charles E. Lowers (W8KJG), and H. F. Babb consists of a pair of '10's in the final, modulated by two 250's in parallel with power reduced to 20 watts. J. W. Sesher and Thomas Weber were the operators at W8HH, which consisted of one 59 in the final, suppressor grid modulated. Ray C. Spence and Jack Ballman (W8FSR) held down the mike at W8FJA, which was the "flea power" of the whole system, an '01A in the final, modulated by an '01A, with a power input of approximately 4 watts. All stations except W8VZ were operated on 1975 kc., which made it possible to work duplex with W8VZ from any of the other stations.

—Charles E. Lowers, W8KJG, Pres.,
Marietta Amateur Radio Society.

28- and 56-Mc. Activity

W6EZZ, W6DDC and W6JDN, of Dunsmuir, Calif., are on 28-mc. 'phone each night at 7:30 p.m. P.S.T. and invite any of the gang to break in on them. W1BEQ, W1DJC, and W1FSE, of Manchester, Conn., are active on 28 mc. and anxious to make outside contacts.

56-mc. interest continues high with more mobile opera-

tion being reported. W6AM, Long Beach, Calif., has worked hams in twenty-two cities, all permanent stations. He has also worked a number of mobile stations and is installing a 500 volt, 200 M.A., motor generator in his car for mobile work.

W9NI—Kansas National Guard

The amateur radio net established between Camp Whiteside, Kansas (W9NI) and thirty-seven amateur radio stations during the Kansas National Guard field training period, 1934, was the most successful of any yet conducted. Schedules were maintained between Camp Whiteside and twenty Kansas Cities and one each in Missouri (W9BMA), Nebraska (W9FWW) and Arkansas (W5FB). The total number of messages transmitted and received was 7719, an increase of about 500 over 1933 when the well known call CX7 was used. The operating staff at W9NI this year included W9ICV, W9PKD, W9KSY, W9LFB, W9OCU, W9ABG, W9BGL, W9KVG, W9OQC, W9IQI, and W9OZN.

Those amateurs outside the camp who participated in the net are as follows: W9PKD, AWB, IGQ, FRC, PB, DZI, OKA, DQJ, FLG, APF, EYY, KFQ, GWN, KXB, IOL, EHA, EFE, JET, CVP, LFN, LLW, IPD, BMA, BGL, YAB, DQJ, AWP, KSY, FET, PEG, IQI, FWW, W5FB. Special credit is due those who handled exceptionally high totals: W9AWP 1234, W9PB 731, W9FLG 615, W9BMA 538, W9FRC 521.

Messages received at camp were delivered by scheduled messengers. At the other stations in the net various systems were used in addition to the radio operator himself delivering by telephone. In Hiawatha a group of amateurs pooled their equipment and set up a station in the show window of the local power and light company office. Messages not delivered by telephone were sent to the afternoon newspaper and reached the addressees by paper carriers. In Wichita a young man interested in amateur radio spent many hours telephoning messages from the station of the amateur handling the key. In Newton the local Guard Company installed station at the Country Club. Boy Scouts were used to deliver messages. In Topeka a boy with a bicycle was hired to make the deliveries that could not be telephoned. Wives and mothers of other amateurs assisted in the telephoning.

The net functioned on 3815 and 3845 kcs., with W9NI on 3620 kcs. to permit break-in operation. The transmitter at W9NI consisted of P.P. 2A5 crystal osc., P.P. '46 buffer, P.P. 211 keyed buffer and P.P. '04A P.A. Input to final was 600 watts.

In 1932 a regular net made up of Kansas National Guard stations located in the armories throughout the state was established. This net functions during the Armory Training period and now consists of the following: W9NI Topeka, W9DZI Kansas City, W9HWW Wichita, W9CIE Salina, W9EHT Hutchinson, W9MTK Burlington, W9ESW Humboldt, W9KVG Lawrence. Net drills are held weekly.

—W. A. Beasley, W9FRC

Through the amateur radio club at Pendleton, Oregon, Mrs. Rothrock, wife of the late Ralph Rothrock, W7PL, has offered his Vibroplex bug key to the most outstanding amateur in the Northwest Division, A.R.R.L. The award, to be known as the "W7PL Memorial Key," will be presented each year at convention time. It can be held for only one year by the amateur receiving it. The 1934 award was to W7CZY of Everett, Washington.

W8DPZ, Fulton, New York, recently had a four-way QSO on 1.75-mc. 'phone with the XYLS at W1DQK, W8FYC and W8IY. He thinks it may be a record of some sort—at any rate, it's not an everyday occurrence to work three XYLS in a bunch. HI.

W8CDT, Williamsport, Pa., with a message for W4BQK, Jonesboro, Tenn., called "CQ TFC Tenn." Imagine his feelings when W4BQK himself answered!

1.75-Mc. Code Practice

Reorganization of the A.R.R.L. 1.75-mc. Code Practice Program is now under way for the 1934-1935 season. Several amateurs have already volunteered their services. W9MQM, La Grange, Ill., is sending code practice from 6:00 to 6:45 p.m. C.S.T. each Tuesday and Wednesday on either 1938 or 1955 kcs. W6CTT, Los Angeles, sends practice each Friday evening from 7:00 to 8:00 p.m. P.S.T. on 1900 kcs. W2FYW, New York City, has offered to transmit on the following schedule: Monday, Wednesday and Friday from 5:00 to 5:45 p.m. E.S.T. on 1955 kcs. Starting about October 15th and continuing until about April 15th W9DNZ, Malvern, Iowa, will send code practice on 1900 kcs. Week of October 15th transmissions will be on Monday and Thursday at 3:00 p.m. C.S.T. Week of October 22nd transmissions will be at 11:00 a.m. C.S.T. Monday and Thursday, and will continue on alternating schedule, one week at 3:00 p.m., next week at 11:00 a.m. W4CZW/W4BANK, Palatka, Fla., plan to start code lessons on 1925 kcs. in the immediate future. Schedule will be presented as soon as available. The Central Colorado Radio Association, Arvada, Colo., has announced schedule for November as follows, transmissions to be under call W9PWU, frequency 1967-kcs.: 7:30 to 8:00 p.m. M.S.T. each Monday, Wednesday and Friday. All of the stations mentioned use 'phone for announcements. Any other amateur operating on 1.75 mc. who is desirous of assisting in the code practice program is invited to drop a line to A.R.R.L. Communications Department listing schedule for announcement in QST.

Amateur Radio Aids Motorcycle Run

On March 11, 1934, the New York Motorcycle Club, of which W2BNJ and W2CLB are members, held a half-day motorcycle trial run from New York City to a point near Peekskill, N. Y., and return. W2CLB and W2BNJ arranged for communication between the club rooms and one of the checking stations in the woods near Peekskill. A transmitter operating under the call W2CLB was installed at the club and manned by W2CLB and W2CJI. A portable rig using P.P. c.c. circuit with '47s, supplied with 350 volts from dynamotor, was installed in a delivery truck and transported to the field location where an antenna was erected among the trees. During trip to the checking location W2CLB was copied solid on a six foot antenna, much important information being obtained. W2BNJ (portable) was used as call at the field location and contact with W2CLB immediately established. W2EMQ acted as second operator at W2BNJ, gathering the information for transmission to the club. The results of the contestants were posted on a score sheet at the club rooms as they were received. This was the first time that amateur radio had been used for checking a motorcycle race sanctioned by the American Motorcycle Association. The entire run covered 87 miles. A snowstorm the preceding day made the run extremely difficult.

Central Carolina Club Meetings

The next meeting of the Central Carolina Amateur Radio Club is scheduled for the first Sunday in November, the 4th, in Charlotte, N. C. All amateurs are welcome, a special invitation being extended to South Carolina hams. The meeting schedule of this "floating club" has been changed from once each month to once every two months. The club's Second Anniversary celebration was held, in conjunction with the Winston-Salem Amateur Radio Club's same celebration, September 2nd at Winston-Salem. Hams were present from Virginia and West Virginia in considerable numbers as well as approximately 100 amateurs from every part of North Carolina.

Let's Get Chummy

By Harry F. Washburn, W2CL*

The following contribution by Mr. Harry F. Washburn, W2CL, wins C. D. article contest prize for this month. Your articles on any phase of amateur communication activity are likewise solicited and may win you a bound handbook, six logs, or equivalent credit applied toward other A.R.R.L. supplies. Let us have your article, and mark it "for the C. D. Contest," please.—F. R. H.

THERE'S one art that has been sadly neglected by the majority of the amateur fraternity. No ham neglects DX, those interested in traffic need little encouragement to increase their traffic totals, but where is the rag-chewer? There are by far too many fellows who just hand out the usual "GE OB TNX FR CALL ---- UR XTAL SIGS QSA 5 HR IN SQUEEDUNK HPE C U AGN 73 ----," and start off on another CQ expedition. Now, do you men working per the above example do that when you visit another amateur's shack? Of course not. You stay and hash things over for hours. Is there any earthly reason why you can't say more than a few syllables when QSO that same amateur? I believe not.

We can't work DX at all times, nor is there traffic on the hook all the time; therefore let's devote that spare time to a little highly enjoyable conversation. Do something more than handing out and collecting reports! It can be done—just take a look at the records of some of the long QSO's which have taken place, one of them lasting over seven hours! I hear someone say, "Well, what is there to gab about?" To him I will answer, "Plenty, O.M." Why not hash over some of the articles and letters which have appeared in QST. There is no better field for discussion than some of the proposals for lessening QRM, eliminating bum notes, high versus low power, etc. So many of them have been published in recent issues of QST that a little pro and con in reference to these proposals would furnish plenty of enjoyment to both sides. Talk about your equipment, the troubles you've had with the BCL's, your pet grievance, prohibition, the Soviet situation, the Brazil-net crop (when QSO with PY), or anything which has general interest. Our art, radio, might just as well take up about 90% of all conversations on the air, but just tune through the 7000-ke. band some time and count the number of ragchews on radio or anything else. Nine out of ten times after the report will come, "GUESS NM HR OB SO QSK 73 ETC—"

My own transmitter is a low-powered job, and most of the time it is futile to call any DX. I do not handle much traffic, so spend my time on the air conversing about numerous things. Each good QSO I have I note, and in that way accumulate a list of calls of fellows who are not in the game solely for reports and CQ's. Anytime I hear one calling CQ, I am practically assured (if I raise him) that said fellow will be willing to gab a while.

At frequent get-togethers of amateurs I have heard certain men spoken of as "CQ hounds," "CX nuts," and "report gatherers." All in question cared nothing for conversation except to get an r9 report from Australia, to raise twice as many K6's as anyone else, or to get a WAC every month. They soon lose any "air reputation" they might have had, and other amateurs will never answer a call from one of these fellows more than once.

Let's start the season right by chatting with your next unseen QSO-mate. Maybe he used to live next door to you ten years ago. You could certainly dig up something to talk about then. Such a QSO would leave you with a feeling of having had a good time, make you give the old transmitter a pat on the plate tank, and say, "Boy, this ham game gets better every day."

W5BMI challenges all comers to beat these records: In 1931 he had 3751 QSOs; in 1932, 4010; in 1933, 3909; and up to September 28, 1934, 2782.

*333 Packman Avenue, Mount Vernon, New York.

Army Transmitter Tests

For the next several months the Communication Platoon, Headquarters Troop, 1st Cavalry (MECZ), Fort Knox, Kentucky, will be conducting tests of various types of Army transmitters. The cooperation of radio amateurs is requested in determining the range, signal strength and readability of the different types of sets. With the exception of the base station all sets are portable and when heard will be operating mobile. One or more of the transmitters is expected to be on the air practically all day and night. Frequencies to be used are 2200, 2308 and 2492 kcs. Power of the various sets ranges from 10 to 350 watts. Calls to be used are JB3, JE2, JH1, KP7, JJ9, JP7, KP3, KE2, KH1, KJ9, KM8, KS6, IB3, IE2, IH1, IS9, IM8, IS6, IV5, JS6, JV5, JY4, IY4, and KY4. Amateurs are asked to listen for these stations and report to Lt. G. V. Morse, Fort Knox, Ky., the call letters, date, time and whether signal heard was voice or c.w. Lt. Morse will be glad to answer any requests for information on the work, sets, necessary qualifications for enlistment in the Communications Platoon, etc.

Briefs

An amateur radio exhibit and station was a feature of the Canada Pacific Exhibition, held at Vancouver, B. C., August 29-September 5. Nearly two thousand messages were handled. See the station activity reports for British Columbia this month for details on amateurs participating.

"QRZ," a publication for the Wisconsin, Illinois, Northern and Southern Minnesota A.R.R.L. Sections, recently made its debut under the editorship of Harold Peck, W9HTZ. It is a newsy sheet and should help greatly in keeping up interest and activity in the territory it serves. Good luck, "QRZ."

Just before noon on Saturday, September 22nd, Mr. Charles A. Rathskopf of Lynbrook, L. I., asked police to help locate his son. All that was known of the man's whereabouts was that he was somewhere in the south, probably Alabama, Florida or Georgia, riding in a Hupmobile sedan bearing New York state license 6R 5521. At 2:30 p.m. Mr. Rathskopf was talking to his son by telephone at Birmingham, Ala. Amateur radio got its man! The Lynbrook police gave the alarm to Nassau County authorities. The service of Dispatcher Bedell, a radio amateur, was enlisted. His own transmitter not being on the air he hurried to Bellmore, L. I., where he knew W2BMB and W2CHK to be active. The message was filed with these amateurs for a general broadcast to all amateurs south of the Mason-Dixon line. W2BMB sent the information QST while W2CHK routed the message via the A.A.R.S. Before 2:30 p.m. young Rathskopf was stopped by police in Birmingham, Ala., where the information had been received by amateur radio! Among other amateurs assisting were W2DBQ and W2BGO.

The Sioux County Fair was held August 21st-23rd near Orange City, Iowa. A booth was given to W9FQT to display an amateur radio station. Combined equipment of W9FQT, W9ABH and W9APA was put on exhibition. A station under the call W9FQT was placed in operation. The transmitter was c.c. having two 800's in parallel in the final. Much interest was shown by those visiting the fair, and a better understanding of amateur radio by the "general public" in that vicinity resulted.

In early September KAINA, Olongapo, P. I., held a two-way conversation with his sister and brother-in-law in the states through the cooperation of W6GHD at Walnut Creek, Calif. KAINA used 'phone while W6GHD used c.w. on 7 mc. The contact lasted from 5:30 until 6:40 a.m. This radio reunion between the relatives was thoroughly enjoyed by all.

W7AZP, W7DGY and W7EKC set up and operated an amateur radio station at the Clallam County Fair, Port Angeles, Washington, August 31-September 4. About 250 messages were originated, all being transmitted to local O.R.S. W7DGY, who relayed through his regular schedules. The station at the fair grounds was operated portably under W7AZP's call. Thanks are extended to W7CZY, W7COU, W7DYG, W7CSK, W7CPF and W7EPT for coöperation in clearing traffic.

The Spokane (Wash.) Radio Operators Club held a most successful hamfest in Spokane June 10th and 11th. Over 90 hams were registered from all parts of the north-west. No fees were charged, the housing committee providing sleeping quarters for those requesting same. An indoor baseball game between C.W. and 'Phone operators resulted in a victory for the 'Phones. The big picnic held Sunday, the 11th, at Liberty Lake, was enjoyed by about 100 hams and their families. The Spokane Club is preparing a similar 'fest for 1934. W7AMA was in charge of this year's festivities.

Members of the Yakima (Wash.) Amateur Radio Club maintained constant communication between Badger mountain and Yakima when Charles McAllister, Yakima aviator, attempted to break the world's glider flight record. Among the amateurs coöperating were W7AYC, CXC, CYO, BUQ, US, AWX, BUX, AYO, AUP, BIW, WQ and AQX. These men, and the many other hams who stood by to avoid QRM and assist in any other manner possible, are to be congratulated on their fine spirit of coöperation.

A message addressed to K6DV originated by W8KWU, Grant Town, West Virginia, was sent to W9LBI, Fargo, North Dakota, at 8:45 p.m. September 15th. The next morning, 10 hours and 35 minutes later, W9LBI relayed the message to K6DV direct. Service, plus!

Speaking of International QRM, W6GAL offers this one. One day about noon on 14 mc. he heard D4BBN CQing with QRM from a K6. D4BBN was called and raised; when he first came back he was QRM'd by LU1EP. When the LU quit and W6GAL began to think he was getting somewhere, who should land down on the D but J2GX! When D4BBN came back a second time to W6GAL's request for a repeat X2C's 'phone had him smeared. The X off, a W1 broke the camel's back with a call to FM8BG! The FM was heard five minutes later about 30 kilocycles away. This all happened inside of fifteen minutes. QRM W.A.C., and how!!

O.B.S.

The following is a supplement to the list of A.R.R.L. Official Broadcasting Stations in October QST (page 49): W1FRO, W1YU, W4BKS, W5AAX, W5BPL, W8HSX, W9HCH, W9YB.

New Members—A.R.R.L. A-1 Op's Club

C.W.: W1ABG CRA DAV DOW LZ W2DBE EGF EWQ EYQ FIS GOX PY QY SN W3ANH AQN BBB BYS NO W4AKH AVD AYW BOU BRK BTU GL MU QL UT W5BZR ZD W6FH FRN GXM W8AQ AZI BQ CRA CSE EDG EQC FEY FWX HB IWT JIN KJW KMT KVA VD W9CSY CUY FWW FXP HPG HUJ LEZ LW MUY NJS VESNO WX VE4BZ VE5GT HQ Foreign: G2MA J2GW PALL VK2BP VP5PZ ZL4FK

PHONE: W4JB RV.

This is a supplement to the complete roster of A-1 Operators which appeared in May QST (page 88) and to the additional list on page 58 of August QST. For complete details on the A.R.R.L. A-1 Operator Club see July QST (page 64). Every active amateur should strive to "rate" membership in this group of recognized "A-1" operators.

BRASS POUNDERS' LEAGUE

(Aug. 16th-Sept. 15th)

Call	Orig.	Del.	Rel.	Total
W2EKM	55	41	1650	1746
W9AWP	585	745	32	1362
W9KQ	156	397	698	1251
W9BMA	240	400	480	1120
W5CEZ	111	59	598	768
W3EOU	112	155	435	703
W3BOU	335	128	308	769
W8DPY	335	120	206	661
W6AUZ	165	237	240	642
W3BWT	107	97	398	602
W6BMC	11	9	570	590
VE5LQ	122	225	230	577
W9FLG	160	278	138	576
K6JPT	—	—	570	570
W1ERQ	67	34	464	565
W7DGY	10	16	500	526
W2BZZ	13	19	486	518
W7CZY	10	30	462	502

MORE-THAN-ONE-OPERATOR STATIONS

W9NI	2921	1535	6	4462
K6EWQ	—	—	2792	2792
VE5CK	1762	30	12	1804
KA1HR	448	419	818	1685
W6ZG	671	486	162	1319
W1MK	48	116	431	595
W9RLD	271	243	1	515

These stations "make" the B.P.L. with totals of 500 or over. Many "rate" extra credit for one hundred or more deliveries. The following one-operator stations make the B.P.L. for delivering 100 or more messages; the number of deliveries is as follows: Deliveries count!

W2BCX, 348	W6ALU, 119	W8LAL, 106
W9YAB, 270	W6GXM, 118	W9FET, 104
W6CWE, 213	W9PHG, 118	More-than-one-opr.
W9KY, 192	W9EHA, 117	W5OW, 241
W3ANT, 188	W9LFN, 115	W9BNT, 143
W2ELK, 175	K4ILG, 114	A.A.R.S.
VE5EO, 148	W3CL, 109	WLNF, 184
W9EFE, 129	W6IDZ, 107	More-than-one-opr.
W9IQW, 126	VE4KG, 106	WLV, 136
W6H2T, 120	W9BGL, 106	

A.A.R.S. STATIONS

Call	Orig.	Del.	Rel.	Total
WLJ	50	39	596	685

MORE-THAN-ONE-OPERATOR STATIONS

WLM	142	206	1714	2062
-----	-----	-----	------	------

A total of 500 or more, or just 100 or more deliveries will put you in line for a place in the B.P.L.

Referring to page 45, June 1932 QST, where VE3TW presented a formula for measuring voltage by use of a "human voltmeter." He said, "if you grab the high voltage terminals in your hands, you will jump back one foot for every hundred volts." Since that amazing formula was announced several other hams have been making "tests," with the following results: W3HD made his test with a transformer rated at 1000 volts in a room ten feet square. When the fireworks were over he found that he had gone the specified ten feet (one foot per hundred volts) but the impression left in the wall indicated that he would have covered many more feet on his journey had there been no obstruction in his path. Now he wants to know if the depth of impression in the wall can be read by a similar scale, or was the rating of the transformer wrong? . . . W5AAD also tried VE3TW's formula (accidentally, of course!) and finds that it is OK. However, he finds that the "angle of deflection" of the "indicator" is downward; instead of backward. He wants to know if it could be the polarity that caused VE3TW to get results different from his! . . . W9FUR would like to know what kind of "multiplier" to use with VE3TW's "human voltmeter" as his room only measures 1200 volts long and he needs about 10 feet more. . . Hi!

When is a message not a message? When it has not been acknowledged by the receiving station!

WHEW and KJTY

From Dunedin, New Zealand, under date of August 27th comes word from Richard D. Watson, WIBGL, operator of WHEW (the ship *Bear of Oakland* of the Byrd Expedition) that a week previously he attended a meeting of radio amateurs of the Otago District, N.Z.A.R.T. The meeting was held to present the B.E.R.U. Trophy to ZL4BT for winning the B.E.R.U. contest. About seventy-five amateurs were present. Radio Inspector O'Grady, ZL4XC, and Assistant Inspector Harris, ZL4XE, were among those at the gathering. A jolly good time was had by all. WIBGL reports that he has not done much work with amateurs from WHEW due to being busy with his regular duties. His schedule with little America has been carried out on 36 meters but now that they are getting more daylight it is necessary to use 27 and even 24 meters for these contacts. Operator Watson has been operating both WHEW and KJTY (the *Jacob Ruppert*) at Dunedin single-handed. He has been averaging about 5000 to 10,000 words per week. In spare time he has been overhauling the equipment on both ships so that they will be in good shape to leave for the Bay of Whales.



NORTH CAROLINA 160-METER PHONE NET MEETING AT W4BYA's SEPTEMBER 2, 1934

Left to right, W4DCQ, W4CYB, W4BV, W4AAU, W4CDQ, W4CEL in back row, W4CXI, W4BYA, W4CJQ, W4BYA, Jr. The geese "C" and "O" are mascots. The visiting dog was at once named QRM.

W6ASC recently performed a bit of notable work. Through the medium of amateur radio he sent dispatches to each sheriff's office throughout California, at the request of Mrs. E. G. Stevenson of Santa Cruz, in an attempt to locate a missing relative. Mr. Griffen of W6ASC is in receipt of word from Mrs. Stevenson that the missing party was successfully located in Santa Clara County, thanks to amateur radio!

The Badaux Expedition to Northern British Columbia has found it necessary to lighten load due to difficulty in traversing the rough country. In consequence the radio gear has been dropped and Bruce McCallum, VE5AT, operator with the expedition, is back home in Vancouver.

The Wabash Valley Amateur Radio Association and the Rose Polytechnic Institute announce a hamfest to be held at the Institute under the supervision of the W.V.A.R.A. on November 17. W9DET, chairman of the hamfest committee is planning many outstanding and interesting features. All hams are cordially invited. Enjoyment assured. Be sure to attend.

Making Your Operating Effective

STATION transmitter efficiency has been stressed to the point where *personal operating efficiency* almost has become overlooked in favor of it. Yet, while the qualifications of the equipment used, especially the transmitter and receiver, are of importance, a cold analysis of QSO-results shows that when all things are considered the accomplishments of a station are dependent in a great degree on the ability and experience of the operator. An article recently published in *QST* went so far as to imply a relative importance of 10% for the station, and 90% for the operator. In this business of establishing and maintaining reliable, interesting, and valuable two-way contacts by amateur radio. While we certainly do not wish to under-rate the importance of full consideration of all the factors of proper station construction and technical adjustment — for these things are of vast importance in bringing about satisfactory operating conditions for all amateurs in our increasingly populated bands — we cite these figures to focus attention on, and ask your consideration of the problems and practises encountered in the operation of an amateur station.

Improvement in operating can work wonders for amateur radio as a whole, and for you individually as well. So let us, in these days of rebuilding, QRN, and QRM, give ample thought to and some study aimed directly at increasing our *personal efficiency of station operation*. Perhaps we are all fairly good operators — but not one of us but can improve our operating work, if we will but try. Our job is to look into our *personal operating*, accept responsibility for it, take pride in such points as may reflect on us to advantage, and apply corrective knowledge toward improving our brass pounding and voice work wherever we find it can be improved by comparison with the established standards.

We must make our minutes and hours of operating yield the *maximum possible* return in results — and enjoyment. Far be it from us to diagnose what particular way YOU can improve. It's a personal problem for each of us to worry about.

Maybe we should dig out the *Operating an Amateur Radio Station*, or the *Handbook*, or examine the "hints" in the front of every A.R.R.L. log book, and ask ourselves a few questions to the point. Better yet, let's ask a friend to criticize our *past operating habits* and give just one suggestion to make our operating effectiveness greater.

Something of interest and value should result when frank answers can be obtained and analyzed. Since it is human nature to "try to please" it may be difficult to carry out the first step in obtaining truthful, constructive criticism which will help us to improve. Radio club groups can most readily work together in studying the operating practises of the individuals constituting these groups. Analysis of the number of QSOs, the time required for completing each, the time required for receiving and transmitting messages, and a list of "reasons" for delays in the process of such communications may prove enlightening and can be carried out individually. Also individual suggestions will be helpful, once we have convinced an operator that his ideas will be accepted in a friendly spirit, and that frankness will be truly appreciated in commenting on such personal matters as "operating."

A long list of operating axioms would be pointless, here. A chapter in *The Radio Amateur's Handbook* is devoted to the subject of operating practises, and available in practically every amateur shack for study of these points. Use it, OM's.

At the National High School Band and Solo Contest held at the World's Fair, W8CPG took first place on the piccolo and second place on the flute! Amateur radio scores again!!

C. S. Hoffman, Jr., W8HD, is now in his *fourth term* (two years each) as SCM of West Virginia. W8HD has been conferred the title of "Dean of SCMs," A.R.R.L. records indicating his appointment as "ADM" in November 1925, some time before a change in League field organization created the corresponding post of "SCM."

Amateurs QRX in Tropical Hurricane

Amateurs were "on the job" when a tropical hurricane neared the Texas coast Thursday morning, July 6th. W5TG, Houston, established contact with W5ATU, Brownsville, and furnished the Houston Post with weather reports from the Rio Grande Valley. W5CHO in Houston was also on the air, and W5ON, W5BHO, W5TD and W5VB stood by to assist in case telephonic and telegraphic communication was disrupted. Assisting at W5TG were his YF and Melburn George, both licensed amateurs. W5TG and W5ATU were in communication until the evening on July 6th when it was certain that the danger had passed.

Hubert Almond Patterson—Please write Mother, 1806 Patterson Avenue, Southwest, Roanoke, Virginia. (Hubert Patterson was formerly a radio operator in the Lighthouse Service located at Fortress Monroe, Va. Anyone with information as to his present whereabouts, please write or wire collect to his mother's address, given above.)

Of interest to radio amateurs, particularly those residing in Alaska, will be the following rule which appeared in the July 1, 1933 Supplement No. 4 to the 1932 Tariff Book of the Washington-Alaska Military Cable and Telegraph System: "Government messages and collect commercial messages from amateur radio stations in Alaska where no other means of telegraph or telephone communication exists may be accepted direct from such stations or from local amateurs who may act as relays. Such messages will be handled as forwarded messages under the provisions of rule 9." Rule 9 deals with the handling of accounts; amateur stations involved must handle no money or accounts. We are indebted to Howard F. Mason of Seattle, Washington, for the information on this new rule. From the viewpoint of the isolated amateur this is particularly helpful, since it connects him with the regular commercial service. It is a recognition of the amateur's value to the small communities having no other means of communication.

We've all heard of peculiar ways of meeting fellow hams, but here's a new one. While at Manasquan, N. J., swimming, W2BPY saw some fellows surf-board riding. He walked on the beach so as to be in front of them when they came in, and lo and behold, there was an A.R.R.L. emblem and all kinds of ham symbols staring him in the face on the nearest surf board! A whistled "Hi" and the rider tumbled off his board, introductions followed and W2EYN and W2BPY had an FB personal QSO.

W1IBY, Herb Gordon, has been fortunate this summer in being located in New Jersey, "where hams are as close together as in the stockyards." He has been visiting quite a number, including W2GBW, the high-powered 1.75-mc. 'phone, W2KR, W2GBT, W2EJA, W2FOZ, W2GCV, W2EMM, W2FGY, W2AEA, W2JJ, W2FL, W2CO, W2GZX, W2HCW, W2BXL, W2BUD, W3ERX, W2GBO, W2AFB, W2GBD, W2FDL, W2EKV, and others; in all he has visited about thirty stations and met forty or more hams! Out of thirty-two stations visited eleven had crystal-control, and only nine had separate means of checking frequency, most of the lads relying on their receivers! W1IBY thanks the "Jersey gang" for a royal time.

STATION ACTIVITIES

ATLANTIC DIVISION

EASTERN PENNSYLVANIA—SCM, Jack Wagensler, W3GS—W3BOL and 8DPY B.P.L. 3CIQ plans new outfit. 3CJI is active in A.A.R.S. 3EOP is running DX contest with 3NF. 8EOH was appointed D.N.C.S. of Penna.

A.A.R.S. Dist. 2. 8KUV is returning to Stevens Tech. 8FLA is building new rig with RK-20 final. 8ASW was heard in VK and ZL on 7 mc. 3EZ is working at night. 8AUH reports via radiogram thru 3EZ. 3EPJ applied for O.R.S. 3AKB handled that entire 100 in just five days. 3CL reports that 3ENK was QSO Switzerland on 3.5 mc. 3EER reports for Beacon Club, 3BUK and 3DYL. R. M. 3ALX is all set for big winter. R. M. 3MC is pounding brass on a ship. The Allentown Radio League is about to put a new 'phone and c.w. rig on 3.9 and 1.7 mc. with RK-20 final. 3DLL finished rebuilding. 3BOP, 3TP, Ek3FR, 3AFG, 3OP and 3DOV have been running 56-mc. tests all summer. 3EGA's XYL is about ready to take exam. 3ADE is working evenings. 3DYX's transmitter went up in smoke. 8DIQ has been appointed A.A.R.S. net control. Over fifty amateurs representing the affiliated clubs of Philadelphia and vicinity attended the recent meeting at the club rooms of the Norristown Radio Club. Please send in your suggestions for an Eastern Penna. Section Contest.

Traffic: W3CIQ 28 BOL 669 AQN 49 CJI 18 EOP 35 EZ 401 EPJ 19 AKB 100 CL 366 ADM 38 BUK 1 DYL 2 EER 8 ALX 254 ECD 224 GS 27 ADM 6. W8DPY 661 EOH 20 KUV 155 FLA 24 TWT 16 ASW 18 AUH 71 LUI 258.

MARYLAND-DELAWARE-DISTRICT OF COLUMBIA—SCM, E. L. Hudson, W3BAK—Ed Day, 3CXL, rode his motorcycle over to the Eastern Shore and spent a week-end with 3BAK. EOU is working C.C.C. Net. BWT is working on 7-mc. rig. BND is QRL A.A.R.S. and C.C.C. Nets, ditto CIZ. CWE has fine luck with 56 mc. BAK is rebuilding. EKJ has an imposing 1-KW 'phone and c.w. rig at Howard Univ. DUK rebuilt rig. EIV/EQZ will have two transmitters on air. EIL was visited by 4BTR. BRS will soon be on 1.7-mc. 'phone. DKM is on with Universal exciter. CDQ is progressing with 56 mc. BHE visited Chicago Fair. DZF wants O.R.S. LA has 60-ft. vertical radiator. 2CYA-3 is operating portable in Wash. The S.C.M. wishes to thank 3CXL/WLM, 3BWT/WLMB and 3BND/WLQC for making separate listing of traffic handled on amateur and special frequencies.

Traffic: W3CXL 180 (WLM 2062) EOU 703 BWT 602 (WLMB 108) BND 291 (WLQC 155) ASO 141 EOG 72 DML 42 CIZ 21 CWE 20 BAK 14 EKJ-DUK 11 EIV/EQZ 7 ATQ 6 CDG 3 EIL 2.

WESTERN NEW YORK—SCM, Don Farrell, W8DSP—The Fort Stanwix A.R.C. annual outing on September 2nd. The high-light of the outing was a soft ball game between the club's team and one piloted by DSS of Oneida. The Oneida team vanquished the Fort Stanwix boys. LUZ left for Univ. of Mich. HJN is back on 7 and 14 mc. The Mohawk Valley Brass Pounders are moving to new location. AOW and DSP and OW's spent two enjoyable days in Washington. We were shown the sights by 3CDQ Elizabeth Zandonini. 3BWT was visited. DSS, R.M., is leading traffic man, followed by R.M. JTT. JSD has new TRF receiver. EUY has regular schedule with ON4CSL. FMX spent some time at Camp Russell on White Lake. KBS reported good time at Binghamton Convention. EMW uses 211-E in amplifier. KMC is QRL Army and Navy. AYD added a '52 to final. EWP joined U.S.N.R. CDK is operating portable from Quaker Bridge. BQJ works plenty of DX. New Ilion hams: MKA, MLJ, MJU. The Central New York R.C. had fine exhibit at New York State Fair. DZF is building new 56-mc. equipment. AQE has three new crystals. DHU is still traveling. LLI reports for first time. GZM is employed by Western Union. CJJ has 300 watts on 14 mc. FYF is taking bugs out of new rig. LGR visited 9USA. KRC is leaving for University of Michigan. DMJ is now located at Lovington, N. M., where he signs 5ENL. We wish Doc the best of success.

Traffic: DSS 483 JTT 409 JSD 108 BUY 89 FMX 88 KBS 61 EMW 59 KMC 57 JQE 43 AYD-EWP 36 CPJ 32 CDK 31 JTP 22 GPS 21 BQJ-LUJ 12 LGY 14 GPT 15 GWT 16 EBR 18 JJJ 9 FTB 7 BJO 5 DZF 3 GWY 3 AQE 2.

WESTERN PENNSYLVANIA—SCM, C. H. Grossarth, W8CUG—KWA is trying Johnson Q. ant. CUG has '03A going. HGG is QRL football. GBC is looking for new O.R.S. CMP is home for winter. IUY wants O.R.S. GSH says API would like to know of any W8 scheduling K6. MKH

is new Jeanette ham. FZG will be using call LWK soon. AYA changed QRA. HJM visited 9USA. CFU is new O.P.S. FKU has checker schedule with EIS. KYW has been helping beginners. GJM says over 300 attended Greater PGH hamfest on August 26th. LSH has new 7-mc. c.e. rig. MCK is new St. Mary's ham. KXP is studying for Class A. IFY and IBX have 56-mc. transceivers. IOI is successfully working 39-mc. 'phone. INE will be located this winter in the Boys' Club, St. Mary's. Visiting hams are invited to stop. Following have formed a network to help eliminate QRM. All use a frequency between 1995 and 1998 kc. PX, KQY, JOP, GDF, EA, CFU, CEQ. How about getting all these stations to become O.P.S. and making it an O.P.S. network? New O.R.S.: IOH, AXD. New A.A.R.S.: JZZ, KSG, KUI, JZR.

Traffic: GUF 331 KWA 106 CUG 98 HGG 65 KD 48 GBC 26 GMP 21 IUY-KOB 15 GSH 14 FZG 10 JZZ 8 ABS 6 AYA-DKL 4 HMJ 7 CFU 4 IOH 3 FKU 2 KYW 2 AXD 1 LSE 6 IOI 5 CAX 25

CENTRAL DIVISION

ILLINOIS—SCM, F. J. Hinds, W9WR—R.M.'s 9AND, I ERU, ILH, KJY. Illinois Day Traffic Contest from 5 p.m. CST, Nov. 26th, to midnight, Nov. 28th. For ILLINOIS stations only. 10 pts. for each S.C.M. or R.M. worked. 4 pts. for each O.R.S. worked. 2 pts. for each station worked (not S.C.M., R.M. or O.R.S.). Contestants must have their reports in to 9WR not later than Dec 3rd. Prizes for highest scores. New antenna at FO. WC is working on directional antennas. MCC is an A-1 operator. SG is back on air. NN visited 6AOR. Ex-FDJ now signs SOW. IWP and NDB worked first VK. HUX has been ill. CUH is DXing. COW handled a 14-mc. 'phone message from BYF to 2HHG, who delivered it by automobile. RDU is going in for higher power. AAR finished his RF unit. JCG is joining A.A.R.S. AND wants to hear from Illinois traffic stations desiring contacts in Illinois State Traffic Net. KEH has portable rig. PNE worked OA4AA, EA2AD, EAAAV. CGT has 'phone working. GET is on 1.7-mc. 'phone. PVN is working with 56-mc. mobile aeroplane-to-ground rig. HB worked an F8. OXA is now A.A.R.S. OLA is applying for O.R.S. New reporters: SEI, RMN, PLL. Rebuilders: RPN, ANQ, PXN, OZJ.

Traffic: W9DOU 27Z (WLT 145) HPG 131 DBO 88 HUM 79 FO 63 RMN 55 OXA 51 NN 47 IEP 30 CKC 33 AND 18 KEH 16 HQH 14 CUH-SG 9 DDO 8 NDB-NXG-PLL 7 MCC 6 LIV 5 HUX-PBQ-RCQ-SOW 4 CEO-DZG-GKH-IWP 3 ACU-COW-PXN-SEI 2 FTX-RPN-WR 1.

INDIANA—SCM, Arthur L. Braun, W9TE—9FQ. Chief R.M. FSG is building rack and panel. NTP wants O.P.S. MQQ is DXing. EQQ likes Collins ant. coup. JOQ is trying 28-mc. 'phone. HUV is rebuilding for bk-in. SOK is new at Gary. JRK gets A.A.R.S. schedules under way. SMA is new at Terre Haute. KDD is now Class A op. FQ has new Jr. YL op. Ft. Wayne Club now meets at Indiana Tech. SFG has new ant. HUO is QRL. A.A.R.S. PQL is on 56 mc. ARK and RE are new O.P.S. EEJ likes 3.9-mc. 'phone. MPR has new ant. towers. JIP and HTX are rebuilding. CHA is QRL N.C.R. HBK moved rig to bedroom for winter. FYB sold his junk. TE wants more hams to report each month. AEA likes RK 18 tube. KOZ has ant. troubles. AUT wants O.R.S. BHM likes R meter on receivers. QG has new rack and panel. MHM gets out fine on 3.9-mc. 'phone. LMD is going back to 'phone.

Traffic: W9NTP 5 AXH 4 MQQ 8 EQG 2 JOQ 3 DET 9 HUF 5 JRK 37 (WLEN 5) HUO 7 RE 4 TE 7 AEA-BHM 1.

KENTUCKY—SCM, G. W. Mossbarger, W9AUH—AUH's total seems to lead this month. FSD reports OOO. HBQ has nice schedules. HCO has beautiful new rig. EDV reports new hams, SDH, SDM. OMW QSOs VK. EDQ says more activity on Army Net. OX is rapidly getting new rig built. BAZ was heard in Germany on 3.5 mc. BWJ reports new club downstate. CDA put up new mast. HPO reports. FQQ moves up from basement. BZS

has new P.P. RK 20s going. Every O.R.S., please confirm your QRA to new S.C.M. Kentucky rejoices in the condition of Mrs. 9OX. Carl, we are glad she is better.

Traffic: W9AUH 97 CIM-HAX-EDQ 15 HBQ 8 EDV-OMW 6 BWJ-CDA 2.

MICHIGAN—SCM, Kenneth F. Conroy, W8DYH—Michigan Nines: GQF hopes to attend Spring Hamfest. CE reports U.P. taking on fall coloring. SOS/SCEU was given a fitting call—he's distressed cause no a.c. at C.C.C. camp! U.P. R.M. PDE is getting fall schedules going. Phone Activities Mgr. CWD recuperates after transmitter break-down. CEX reports OZM gave up his 2nd love. OZM wants to know who can take care of RIT's YL while she's in Detroit. PSD changed QRA. PCU sports O.R.S. HK has nice pile schedules. ADY is plugging his new crystal business. RHM got job. OXL vacated his ice-house for inside operating position. MXN works A.A.R.S. schedules. CWR had one out-of-town ham visit him this year—PSD! HSQ contemplates joining Navy or Coast Guard. Michigan Eights: BMG nearly cut finger of his FB fist. GRN's 3rd QSO with new rig was VQ4CRP! CTD echoes, "Dusting the rig—won't be long now." JIU and MBM both send posies about D.A.R.A. Bulletin. GQS and DZ are working on apparatus to harness summer-time static for use in winter-time-brass-pounding! LSF reports new ham, MPR, as 14th in half-mile radius! AIJ wonders how BTP got engaged to Holland, Mich. YL. LSU reports much success with 12-watt voice rig. DPE works hard on C.C.C. organization. KYS' kingdom for some schedules. ICM meets nice YL in Montreal—told IIA about her—now ICM won't take IIA's Montreal traffic! Best luck to CAT, married man, now! IWM boasts 47x-10. IDB is now R.M. of West Detroit. DED is now printing "Gil" cartoon QSLs. JO would appreciate reports on hearing SXQ or 8XR. Glad DWB is back in harness. JZD is known as "Twin City Traffic Hound." KOX will maintain North-South Trunkline this season. RP starts another code class. QT complains of Detroit boys turning B.C.L.'s! DVC keeps east-west trunk going. LAL and ELD kept schedule with boys' camp. FTW rebuilds. GUC wants more recruits for A.A.R.S. ARR needs more U.S.N.R. men. DYH needs more O.R.S. and O.P.S. MGQ planned portable with him at college—but OW says "Study!" LFA reports Jackson ARC open for season. Congrats to LAL: 8½-lb. YL. ECI read S.C.M.'s article in Central Div. Convention Program Souvenir and so reports! 9HEL will be splitting ether from Hazel Pk. with 1 kw! 8GHP is working for O.R.S. CSL puts new antenna five feet higher after tornado hit other one! IFD's YL is back in town! Report between 16th and 20th to S.C.M. Receive free copy of D.A.R.A. Bulletin.

Traffic: W8GUC 365 FTW 237 AEQ 223 LAL 173 DVC 155 QT 112 EGX 68 KOK 60 CPV 52 BTP-JZD 46 IOR 37 DWB 27 ICM 25 FX 24 JO-DED 22 DYH 20 IWM-KXT 19 KYH 14 ARR-LZV 17 IFQ-IA-KYS 13 DPE-JCS 10 LSU 9 GDR 6 AIJ-LSF 5 EGI-FRW-IPX-KNT 4 DSQ 3 GQS-HBZ-MBM-MGQ 2 CSX-LFA 1. W9PCU 37 PSD 33 HK 30 ADY 26 REM 23 PDE 14 CWD 12 CEX-OZM 8 HSQ 7 CWR-MXN 2 OXL 1.

OHIO—Robert P. Irvine, W8CIO—HCS, new R.M., leads state. UW/WLH is doing good job as alternate C. A. N.C.S. DVL married S.C.M.'s daughter on July 28th, and says no QRM as yet. HMH is experimenting with 28 mc. EQB says ZL, VK and South American DX O.K. on 7 mc. AQ has new SW-3. EPP is busy with A.A.R.S. BON operated at National Air Races. KWJ is working lots of DX. APC has new transmitter and receiver. KQO is always on lookout for rag-chew. JIN has 841 final, 100 watts. BKE is rebuilding. ARW operates 100% 'phone. MMF using 10 watts input has worked all but 6th and 7th districts. AMF says someone set mail box on fire and burned up his QST while he was at camp. HSX signed up with A.A.R.S. FGC is trying hard for Asian for W.A.C. DZO's new QRA: 311 N. Broad St., Lancaster. RN is still operating on Steamer Michigan. BAC has new 50-foot mast. BAH works 1.7-

mc. 'phone. LNG worked 1HPV with '01-A in Hartley with 157 volts on plate, 2.5 watts input. KIP has new 32-A Collins. LGL is new station of Good Year Short Wave Ass'n. BRB is back on after rebuilding. Norwalk Amateur Radio Ass'n (8DDQ) is rebuilding. Garfield Heights Radio Club is starting up again. Goodyear Short-Wave Radio Club Officers: 8FNC pres., LEU v.-pres., HCS secy.-treas. BNC and FGJ are leaving for Ohio State University. Nice net formed in Clermont County. Among those already in are EOQ, MPK, LNG, DND, DEI and KZT. FOQ is with C.C.C. LPZ entered college. MFN and MFM are new Norwood hams. DND reports new Jr. operator arrived Aug. 28th, and has DND for his initials; also reports Sept. 1st concludes two-year period of operating during which he contacted 362 different stations, 1865 QSO's, 510 QSL's. 59% of stations QSL'd. FGV, holder of the R.M. party record, has entered college and resigned R.M. post. Sorry to lose you, OM. CHC is new O.O. and O.B.S. DXB is new O.P.S. IAI and KVD want O.P.S. KVX, LCY, DVY, GUL, KMD and DWT will be O.R.S. GDC is now Chief P.A.M. Reported by radio: EIT, LZK, LZE. Back to school go MCU, KZL, EQC. The convention at Columbus was very FB and every one had a "grand time." Good speakers, a good program, and plenty of prizes made the affair a big success. Talks by Mr. Reinartz, WIQP, and Mr. Schnell, 9UZ, went over big with the delegates. S.C.M.'s 9AUH and 9APY were among those present.

Traffic: W8HCS 269 UW 106 (WLHI 103) BBH 30 (WLHA 146) CIO 107 (WLHC 43) HGE 52 EIT 40 DVL 39 HMH 28 WE-EQC 24 EQB-AQ-EPP 22 LZK 18 BON-KWJ 17 APC 16 KQO 12 LCY-JIN 11 MCU 10 BKE-LZE 9 MCQ-ARW 8 GSO 5 MMF 4 AMF 3 HSK 2 FGC 1.

WISCONSIN—Acting SCM, E. A. Cary, W9ATO—ATO is moving again. SDK is QRL school. OKS handles four schedules. OXP is trying to increase output. PQU is putting better signal into Milwaukee. NSM uses TNT. RKP is getting set in new location. HSK is on schedule again. LFK threw out unbalanced split stator in final and increased output 300 percent. OUT uses Hartley. FAV worked 55 countries and W.A.C. six times this summer. All Oshkosh hams, COG, FAV, CCI, are W.A.C. on 14 mc. STH is new Wauwatosa ham. PCH is back in Mosinee. RSA gets r.f. burns off grid cap of r.f. stage in receiver. ZY is operated by EPJ. PZN is at U. of Minn. EXH and ETM are rebuilding. IFS has new FB7. BOP is moving to Florida. New call 4BSY, NKP is first O.P.S. in Wisconsin. How about more O.P.S., boys?

Traffic: W9IQW 143 ATO 104 SDK 80 OKS 45 OXP 29 PQU 23 NSM 18 RKP 15 HSK 12 LFK 11 OUT 10 NZY 5 FAV 2 ETM 1.

DAKOTA DIVISION

NORTH DAKOTA—SCM, Fred J. Wells, W9JVP—PAI has new Pr10 receiver. PDC's new QRA is Thompson Falls, Mont. FVV is going to college. JZJ's mother died. We are all very sorry to hear of this sad happening. DGS and JRC are working with 56-mc. rigs. PHH is putting rig on 3.5 mc. SNP is new Fargo call. EIG is putting in c.c. DTP is new 14-mc. 'phone in Fargo. PRU is QRL fishing. HJC is QRL getting new Army net working.

Traffic: W9KBE 63 HJC 3 (WLUI 24) LBI 23 PAI 18 KZL 15 PGO 14 BTJ 7 PDC 6 FSF 1 JVP 9 FVV 2 MZE 4 SNP 3 PQW 15 SHI 1 SAW 6 LSH 3 OEL 7.

SOUTH DAKOTA—SCM, Mike Strahan, W9PFI—FOQ has Silver s.s. super. OQV moved to Sioux Falls. MBA reports three new Platte hams: SMS, SOB, SMV. SMZ is new Sioux Falls ham. SGI is new at Kimball. RLM is trying 1.7-mc. 'phone. DGR took the final step. Congrats, OM.

Traffic: W9FOQ 72 OQV 36 TY 28 ALO 25 MBA 8 RLM-PFI 6.

NORTHERN MINNESOTA—SCM, Robert C. Harshberger, W9JIE—IGZ, FEP, ISC and IGZ entertained Minn.-Dak. Radio Club. LSC is teaching school in La Porte. OOU-9 is opr. for GH5 C.C.C. Net station.

BVI and HDN have worked all continents. FTJ has FB7A. RLD's traffic was all handled from Camp Ripley to Davenport, Iowa. JIE was visited by 9GDH of K.C. and 9JZJ. AVZ writes from Tuxpan, Mex. He has been op. on Norwegian Spark.

Traffic: W9RHY 20 IGZ 13 SMG 4 OOU-9 7 OMI 2 OOO 14 LAY 2 HDN 14 FTJ-RJF 16 RLD 515 JIE 71.

SOUTHERN MINNESOTA—SCM, Francis C. Kramer, W9DEI—KDI and FCS attend Milwaukee Radio School. EGG has work in Chicago. BNN is using the same old wreck. RAU enters U. of M. Chemistry School. RHT is going on 1.7-mc. 'phone. EFK says plans going forward for convention in spring. OGU has OSA's going. RKG applies for O.R.S. OAK is QRL canning. MOW spends much time experimenting. DCM is active on 14 mc. DEI worked 102 stations in two sittings! RAB is looking for work. ADQ took Class A exam. RBW can't decide whether to buy new car or go in for higher power. AC8EC returned to Shattuck. MMO got an R9 report, and now can't be pried from his rig. ZT tried 7 mc., but is back on 14 mc. AIR hopes to be home for S.M.R.A. Convention. ELA was QSO LY1J for his 48th country. JQA will have c.c. rig using '10s final. HOC put up a half-wave 7 mc. vertical brass-pipe antenna. FIQ has portable sound equipment. X-IRH works in a brewery! BTZ works 7 mc. only.

Traffic: W9DEI 105 FCS 28 BNN 20 RAU 18 RHT 15 EFK 12 OGU 7 RKG-OAK 5 MOW 3 DCM-RAB 2 ZT 1.

DELTA DIVISION

ARKANSAS—SCM, H. E. Vette, W5ABI—BMI keeps a new rig hot. DRY worked 3 VK's and a K6 on 7 mc. DRW has fine schedules. BED has 2½-watt input on '01A. ABI works 3.5, 7 and 14 mc. CGT handled traffic for party in L.R. Hospital. AAJ is A.A.R.S. D.N.C. DRR made cruise to Haiti with U.S.N.R. CZG-DVI completely shielded rig. DHU plans larger rig. CVO took exams for N.C.R. ABL applied for O.R.S. EIP QSP'ed 13 messages from K6. CIU has new bug. DTI is going in for service work. BSG worked several VKs. BDB worked K6 on 14-mc. 'phone. DSW is on 1.7-mc. 'phone. DHG uses suppressor grid mod. DFZ has new super het. UI has new Patterson PR 10. EAR is going 'phone. DWL is building a.c. receiver. FB is proud of his 8-lb. baby girl. Congrats, OM. DUS worked LU2. ENH is new North L.R. ham. DHV is rebuilding into 1000-watt rig. DYI is on 3.5 mc. MU is with U.S. Dept. of Agriculture. EEJ has trouble getting c.c. rig going. ASG likes to rag-chew on 'phone. WA joined Signal Corps. CPV is in Hot Springs until summer. DRZ says fishing fine on Lake Hamilton. CEO has 120-watt 'phone. AQD is new O.R.S. ANZ, EKF and EMU are on 1.7 mc. PX has panel job. DYS has 40-ft. pole. AIK has pair '03A's in final. Following visited S.C.M.: DFZ, DEG, DRR, BJH, DRZ, CGT, ABL and BMI. A traffic contest is being held in this state. Everyone is invited to take part. The contest will run for five months, with a prize each month for the operator handling the most traffic and a grand prize at the end of the contest. All you have to do to enter is to send in your reports and traffic totals each month to the S.C.M. Let's have some real traffic totals!

Traffic: W5BMI 68 (WLUA 81) DRY 134 DRW 110 BED 106 ABI 96 CGT-AAJ 47 DRR 43 CZG/DVI 32 DHU 29 CVO 21 ABL 14 EIP 13 CIU-DTI 12 BSG 11 BDB 9 DSW 7 DHG 5 DFZ 3 UI 2 EAR 1.

LOUISIANA—SCM, W. J. Wilkinson, Jr., W5DWW—BMM works all 'phone bands. KC works DX. BPL is 100% 'phone op. DXK has M.O.P.A. 56-mc. rig. CTR has new 7-mc. rig. EMS is new Shreveport station. ELF is new N.O. ham. BYY is rebuilding. AVO is home from cruise. DYR had visitor from Mexico. DMF visited 9USA. ACV works 56 mc. only. JW is burning up his P.P. '10s. LA does fine on 14-mc. 'phone. GR drives an Austin. AEH and ABS work 56 mc. CWX is on 3.9-mc. 'phone. DES was heard on 56 mc. in N.O. DIQ received card from G. ST won \$10 cash prize at N.O.R.C. CJO is rebuilding his automobile. Following

are active: HR, DKR, EDZ, BYQ, BPN wants O.R.S., O.B.S. DJI visited DKR. AOZ is building 56-mc. rig. AXU works 14-mc. 'phone DX. EDY will install RK 20's. CFF has gone to Miss. CMV has gone to Texas A. & M. EAI holds down 1.7 mc. in Shreveport. AGM wins all main prizes at convention. BZR and CMQ attended convention. ICLX visited CMQ and BZR. AQC has new 50-watt. BBW is laundry man. Send envelopes for DX QSLs to 2749 Myrtle Street, New Orleans, La. (5th dist.).

Traffic: W5KC 5 BPL 4 HR 62 CTR-ELF 2 DLD 5 DKR 22 AOZ 14 EDZ 17 AXU 6 EDY 10 CMQ 24 BZR 198.

MISSISSIPPI—SCM, J. H. Weems, Jr., W5CWQ—AQW is building new 'phone. CLD is managing Miss. A.A.R.S. Net. DEJ has new 830. BYE, CJB, CWQ, EBF, and DDL are at Miss. State College. The North Miss. A.R.C. is going strong. CUU uses remote control. Help to bring Miss. to the front by reporting your activity to the S.C.M.

Traffic: W5DEJ 15.

TENNESSEE—SCM, Merrill B. Parker, Jr., W4BBT—This report prepared from reports received from the secretaries of the Nashville and Memphis clubs, and an individual report from W4ZP. ZP took important message from Chile and delivered by W.U. to Arizona; he is now W.A.C. Nashville news: AFS, operating portable at T.N.G. encampment, Tullahoma, handled 139 during June-July month. BMH is rebuilding. BM has rebuilt in new rack, of two by twos with Masonite panel. AYE has new c.c. rig. Memphis news: SW has new 14-mc. 'phone. AKB works N.C.R. schedules. CUF and 5DMJ have combined stations. CPS helped 9ICP locate relatives in three states by radio. ARL is on 28 mc. ABY and BCA left for N.C.R. cruise to Panama, Oct. 12th. Vt. was busy with Delta Convention. CQI is back from Chi. Fair. DCH is new ham. ADT is on 14-mc. 'phone. AMI and AQD are leaving for Univ. of Tenn. CU plans to work 3.5 mc. this winter. ALM and AEP are active with A.A.R.S.

Traffic: W4ZP 2 ACU 16 ABY 17 CPS 12 ALM-AEP 10 CU 6.

HUDSON DIVISION

EASTERN NEW YORK—SCM, Robert E. Haight, W2LU—BZZ was busy entertaining some of President's party at camp. EGF tries ETH's ball type ant. per QST. LU was visited by 1UE, 1CJD, 2QU. BJX reports fine activities of M.H.A.R.C. UL's receiver rack job is perking FB. ESO is perking out with '47 Hartley. KW worked LU6ER. QY is back at school. CC received W.A.C. CAZ enjoys O.P.S. QSO Party. GRY is on 3530 kc. ATM is active in N.C.R. CBN sports a classy QSL card. GNI schedules BLU. GPB is back to high power. CJS is looking for door prize at S.A.R.A. hamfest. BOG gets glass arm grinding crystal. HI. BPH erected 250-ft. ant. FSD moved to Rochester. GFD reports new club (Colonial City Radio Club). GWY gets out FB on 1.7-mc. 'phone. CVT works DX on 7 mc. DWO is active on 56 mc. HES has pair of '45s P.P. TNT. GXE is active on 3.5 mc. HOK is Ex-9JOY and 7BKY. CJP is testing with single wire feed ant. GOR has $\frac{1}{4}$ kw. on 7 mc. GNB increased power to 400 watts. EZO schedules K4AAN. All members of E.N.Y. Section express their deepest sympathy to 2BMX upon the passing of his wife. GID applies for O.P.S. and O.R.S. HNH visits 9USA.

Traffic: W2BZZ 518 EGF 326 LU 198 FQG 189 BJX 127 UL 50 GTC 35 ESO 34 KW 22 QY 9 CC 7 CAZ-GRY 6 ATM 4 CBN 3 GNI 2 GPB-BLL-CJS 1 BOG 7.

NEW YORK CITY AND LONG ISLAND—SCM, E. L. Baunach, W2AZV—ELK holds a seven-day schedule. CHK is c.c. on 3710 kc. DBE has seven schedules per day. EYQ is op at local BC station. GLJ has 175 W. input. DUP is trying to get on 2 $\frac{1}{2}$ and 1 $\frac{1}{2}$ meters. EYS is on 3574 kc. CYX had *Morro Castle* traffic. FF worked 10XDA off Godhaven, Greenland. ADI rebroadcasts O.B.S. on 28 mc. FDQ joined A.A.R.S. AJR sends first report. AZV gets out F.B. with vertical ant. HAK oper-

ates on 3701 kc. HBO worked DBN, who says he is 71 years young. HBK has new '03A rig. FIP is on 3580 kc. EVA is heard on 7005 kc. BTF worked VP5ST, took message by 'phone and gave him reply. DRG is building Tri-tet. DOG is in Chicago. US has Patterson receiver. GEI reports new club forming in L. I. City. GQC is c.c. on 7 mc. using xtal outfit. GOO is on 7 mc. GSF reports new club forming. EQA is second oping at EYQ. EWS attends school in N.Y.C. BEF is out for DX. FJW had F.B. vacation at Montpelier, Vt. EAF uses flea power on 56 mc. FSD will locate in Rochester. OZ was recently greeted by a Jr. op. CCD uses two '04's self-excited. GLS received first-class 'phone endorsement to his second-class telegraph ticket. DRT worked 6JYH in Los Angeles on 1.7-mc. 'phone. HGM found a spider inside the glass envelope of the rectifier; that was what made his signals "crawly." HJQ is coming on with P.P. '45's.

Traffic: W2ELK 371 (WLNJ 18) AYJ 165 CHK 138 DBE 223 EYQ 100 DJP 97 GLJ 75 DUP 40 AND-EYS-CYX 36 FF 32 DBQ 31 FDQ 32 AJR 22 AZV 19 BGO 18 GMS 25 AMW 19 HAK 7 HBO-HBK 6 FIP-EVA 3 BTF-DXO-CEH-DOG 2 DRG AXN 1 CCD 12.

NORTHERN NEW JERSEY—SCM, John Rideg, Jr., W2EKM—EKM renewed trunk-line schedules. BCX is lining up schedules for local boys. CIZ has rig on exhibition in theatre. FOP handled traffic American Legion Bazaar. CGG handles traffic for C.C.C. camp, W. Orange. BSZ is back for winter. ECO is installing 50-watt. GGW enjoys his 1-watt rig. W3ETX reports for first time. 2HNK, West Essex Club, is active. CJX is roaming through Canada and Chicago. ABS worked ON4CSL. CTT installed a '10 in final. FQR has c.c. on 3.5 mc. DEN resumed activity in A.A.R.S. GPA reports following active in West New York: HDU, FAV, GCC, CKM, EIG, BBK, EDK, ESY, ETC, HED, EDI. 3EWI is now a resident of Newton, N. J.—Ex-2CVL. 2CLM, GPH, EXQ, GFF, AMF, BXM, FKF, DLF, AFB are active 56 mc. GNW is attending Pratts Institute. DPA is rebuilding. HAE reports for first time. CTT, FRC, GUN, DYM, BZC are attending Rutgers University. JC, Bloomfield Club, resumes fall activities. EMN received O.P.S. FRC and ZC handled *Morro Castle* QRR traffic to Savannah, Ga. EIC moved to N.Y.C. 69 active stations sent in report of their activities. A record for N.N.J.!

Traffic: W2EKM 1746 BCX/LK 411 (WLNJ 223) CIZ 111 FOP 90 CGG 71 BSZ 36 ECO 34 GGW 31 ETX 28 HNK 23 CJX 18 GGE 26 ABS 14 CTT-FQR 10 DEN 5 BPY-HDU 3 HED-GCC-CKM-CLM 2 GAS 16 BJK 1 HAE 2 FRC 3 ZC 6 EKV 98 EIC 9. W3EWI 2.

MIDWEST DIVISION

IOWA—SCM, Phil Boardman, W9LEZ—9ABE, Chief I RM. 9CWG, 9HCH, 9HMM, 9HPA, RM's. Interesting reports received from Northeastern Iowa Ham Club, Tri-City Radio Amateur Club, Iowa-Illinois Amateur Radio Club, Dubuque Radio Amateur Club, and Council Bluffs Radio Operators Club. ACL again leads. HCH expects new job. LEZ helped arrange police radio schedule. NZW and CWG visited 9USA. NJD is hunting DX. GWT resumes U.S.N.R. work. IPC is new pres. I.I.A.R.C. NDN is new O.R.S. RDK is champion hitch-hiker. LCX has new rig. CYL is active on 'phone and c.w. DEA decides being a ham is fun after all. MXO is back at college. MXC has only 4 watts input. KMJ is looking for 3.5-mc. DX. SCA uses pair of RK20s. PBF enlisted in Navy. HMQ is building s.s. super. IYV is back to c.w. LYA has nice 'phone. SEE has new antenna. PGG, GMM and IBR are having fun on 56 mc. JRY uses Collins unit. CCY has new mike. MHV is back home. REV is on 3.5 mc. PJG is rebuilding. HMM is starting State Traffic Net. ABE can be found on 3.5 mc.

Traffic: W9ACL 114 HCH 32 LEZ 29 NTW-CWG 24 NJD 13 GWT-IPC 7 NDN-RDK 4 LCX 2 JXO 40 RVR 16 ABE 44 HMM 25.

KANSAS—SCM, O. J. Spatter, W9FLG—9KG and 9IOL CW RM's. 9ESL, P.A.M. NI (CX7) again sets the pace for an all-time record of over 7700 (in one month) messages handled, every one delivered. The

Kansas gang showed a wonderful spirit of cooperation during camp period. LFN, ICV, and MUY go to K.U. AYE is active in Wichita. LFB started c.c. rig. OZN is experimenting with aeriels. DMF has Class A license. W.A.R.C. had two visiting hams from Hartford, Conn., at Sept. 13th meeting. The club has started plans for delegation to Topeka Convention. IOG is chief operator at Ft. Snelling, Minn., C.C.C. camp. IQV has new rig with 59 crystal, '46 and '10. CDM is O.R.S. applicant. Kansas A.A.R.S. is in full swing for winter.

Traffic: W9KG 1251 NI 4462 AWP 1362 FLG 576 YAB 282 KSY 263 BGI, 206 FET-IPD 189 EHA 187 LFN 179 PHG 173 EFE 152 HSN 149 IQI 148 IOL 136 NJS 99 FRC 96 JET 72 CDM 42 DQJ 33 OQC 31 IQV 9 RQE 7 MUY 2.

MISSOURI—SCM, C. R. Cannady, W9EYG-JPT—BMA holds six daily schedules. SOO is new K.C. ham. NNZ is adding 865 buffer. DEN has trouble with Tri-tet. BUL is taking small portable to Palo Alto, Calif., until June, 1935. DIC put up new 50-foot mast. ENF moved station to 2012 Joplin St. ARH is ironing bugs out of Tri-tet. AHH is leaving for Ames, Iowa, to take up E.E. MZF is on after four months' vacation. HVC has new Jr. opr. JAP put '03A in rack and panel final.

Traffic: W9BMA 1120 AIJ 53 NNZ 46 CRM 39 DHN 25 BUL 13 JPT 12 EYG 11 DIC-HUG 9 ENF 8 ARH-DLC 6.

NEBRASKA—SCM, S. C. Wallace, W9FAM—BNT is starting the ball rolling again. FWW has been going strong all summer. FYP is newly appointed P.A.M. EHW has station completely rebuilt. KVZ is trying to put Omaha on map. DI is getting traffic lines lined up. FAM built 1.7-mc. rig. EWO is QRL radio service and motor work. FXP has new outfit on air. FWC is lining up 2nd Dist. A.A.R.S. GKZ loses lot of sleep DXing. JAQ reports new YL opr. at Valentine.

Traffic: W9BNT 295 (WLU 59) FWW 184 DMY 27 FAM 23 FYP 17 EHW 12 KVZ 10 DI 9 BQR 2 EWO 1 RUJ 43 FWC 9 GKZ 4.

NEW ENGLAND DIVISION

CONNECTICUT—SCM, Fred A. Ellis, Jr., W1CTI—RM's 1BHM, CJD, AFB, AMG, MK BPLs both ways again. AMG rebuilt power supply. CVL, new O.R.S., wins C.B.A. Traffic Banner second time. VE did some 56-mc. work with transceiver. DOW keeps four schedules. CJD is busy with Conn. Traffic Net. GKM was visited by VE2BU. FIO installed crystal keying for break-in. All traffic at QV was with Europe. BDI is busy with Unit 1, Sec. 1, N.C.R. DJG, ES, GWO, MY and IFQ are active in this Unit. TD had to dismantle due to redecorating in radio room. BIH is starting junior year at Worcester Tech. GTW has college QRM. HXZ sent first report. HAG attends New Britain Teachers College. BQS is trying 7 mc. IGR is new Branford ham. New officers Bristol Radio Club: Pres. IDBG, vice-pres. DMV, secy. DOW, treas. EUF. ETE enlisted in U.S.N.R. NY1AA visited C.B.A. and local ham shacks while home in Norwalk on leave of absence from Canal Zone. If you are not listed in Conn. Net, there is still time to get in touch with ICJD for schedules. BWM took portable receiver to Maine and got news of home from CTI. The annual meeting of Conn. O.R.S. and O.P.S. was held at HQs Sunday, Sept. 23rd. An interesting discussion of organization problems was followed by adjournment to eating places and local ham shacks. The meeting was fortunate in having two out-of-town guests, NY1AA from Balboa, C. Z., and W8DHU, O.R.S. from Glens Falls, N. Y. Others present included: CTI, CJD, AMG, FIO, AFB, DOW, HSX, EAO, BDI, GGX, QV, BIC, Hal of IMK, APW, ES, GTW, UE.

Traffic: W1MKG 595 AMG 144 CVL 134 (WLG1 97) UE 124 DOW 92 CJD 76 GKM 49 FIO 48 GGX 29 QV 26 GME-AGT 15 BDI 14 CTI 13 TD 12 APZ 11 BHM 10 HSU 8 BIH 6 BNB 5 GTW 3 HXZ 2.

MAINE—SCM, John W. Singleton, W1CDX—BTG has three-stage c.c. rig. EZR keeps Auburn on map. AQW says picking up again. GOJ has new FB7. DHH

maintains two schedules. FQU applied for O.R.S. BLI handles traffic with CP1GB. ARV is first Maine O.P.S. Mr. Pierce of ARV is Maine 'Phone Activities Manager. Mr. Quint is owner of ARV. The 'phone men are holding a QSO party every Sunday afternoon at 4 o'clock. CPT works long hours. IDN is on 56 mc. ERO and ERB want O.R.S. IEH plans new rig. IBM wants schedules. CRP visited A.R.R.L. HQ. IJF is new Fairfield ham. EFA has first-class commercial ticket. CDX handled traffic with SU2NP. HUX is rebuilding. EEEY is bothered with power leak.

Traffic: W1BTG 108 CDX 58 EZR-ERB 42 AQW 35 GOJ 21 DEH 14 FQU 18 ARV 10 BLI 14 CPT-IDN 8 ERO-IEH 6 IBM 5 EEEY 15.

EASTERN MASSACHUSETTS—SCM, Joseph A. Mullen, W1ASI—ASI finds 56 mc. good for traffic. ABG is active in U.S.N.R. KH and WV both worked ZC6FF completing their contacts for W.A.C. EVJ has plans under way for county net. RE is back on 3.5 mc. BZO is hunting a job. FRO was just appointed O.B.S. GCL will be on for county net. BR returned from vacation. DFE has new 849 mod. BSF reapplied for O.R.S. HKY is going back to school. Thunder storm put ECK out of business. CEL is coming down home stretch for O.R.S. IAV is moving from Section till summer. Let's make this year bigger than last. How about another Boston ham-fest? Let's hear from you.

Traffic: W1ASI 20 ABG 61 KH 70 EVJ 17 BZO 49 FRO 67 FPO 5 DFE 4 BSF 20 HKY 16 ECK 54 CEL 112 IAV 158.

WESTERN MASSACHUSETTS—SCM, Percy C. Noble, W1BVR—DVW, chief R.M., is handling correspondence end of his job from Wesson Memorial Hospital in Springfield. EOB and GZL are new O.B.S. (GZL on 1.7-mc. 'phone). EOB is running schedule with HOD for traffic between DVW and his parents. EFM handled Morro Castle traffic. BVR is plodding along at key of WLG. GUO will be O.R.S. soon. DUS keeps busy sending O.B.'s. COI was visited by AXA and 2GTC. BVP is doing fine work on 14-mc. 'phone. BNL spends 75% of his radio time experimenting. AJD has new 56-mc. receiver. GXL installed Collins antenna system. ARH is building Universal exciter unit. DIE reports Worcester Club reorganizing.

Traffic: W1EOB 158 EFM 56 BVR 19 (WLG 274) HOD 12 AWW-GUO 11 DVW 9 DIE 5 DUS-CCS-COI 3 ARH-DDK-GXL 2 ASY 1.

NEW HAMPSHIRE—SCM, Basil Cutting, W1APK—The Twin State Radio Club of West Lebanon has an FB club house. Members are: EFC, EMQ, DMI, AAK, DEZ, CNX, EWF, IDQ, ELR, FN, ELJ, GTY and GOA. HJI has pair of '46s final. CUN worked his 43rd country on 14 mc. AFD has new OM opr. at his shack in Hudson. Congrats, OM. CCM has new c.w. rig. GET made change in his rig. HQE is on 1.7 mc. HTO is c.c. on 3625 kc. TA works 56-mc. mobile. IDY moved into house for winter. ANS joined 56-mc. gang. GEY is on 3.9-mc. 'phone. IGI is new Nashua ham. FGC is recovering from broken arm. FFZ is leading traffic man. GPN celebrated his 16th birthday. HQS will be on 1.7-mc. 'phone. GKE has new monitor. DMD has pair of '10s on 56 mc. AVJ is rebuilding with RK-20 driving '52. AVG is rebuilding. The S.C.M. visited FCI at Intervale. HPM has Harvey rig on 56 mc. on top of Unconoonuck Mt., 1350 feet high. BDN operates on same Mt. BCP has fine 3.9-mc. 'phone. IJB is new Suncook ham.

Traffic: W1FFZ 106 GET 24 GEY 1 HJI 16 CUN-CCM-IDY 2 APK 23. EQR 565.

RHODE ISLAND—SCM, Albert J. King, W1QR—HRC is struggling with frequency meter calibration. IEX has returned from camp. HVK wants traffic. GTN complains of harmonics. QR has moved to East Providence.

Traffic: W1GTN 11 QR 5 HVK 4 HRC 3. (WLGK 42).

VERMONT—SCM, Harry Page, W1ATF—GNF has new transmitter. FPS sends 'phone O.B. daily at 5:30 p.m. EST on 1884 kc. GGT is becoming DX hound! BJP visited N.H. S.C.M., APX and P.A.M., AUY. BJP entertained TJ and EBF. AXN reported by land line!

There are to date 46 members of A.R.R.L. in Vermont. Come one and all! Drop a card to your S.C.M. on 16th of each month. Never mind if you handle traffic or not—let's hear from you.

Traffic: W1BJP 30 ATF 15 GNF 13 GGT 8 GAE 5.

NORTHWESTERN DIVISION

ALASKA—SCM, Richard J. Fox, K7PQ—VH has PR-10. BZX is making a boat and airplane trip over whole territory. CSZ is making tour of States. CTU visited PQ. DWM is back on air. AIB, QG, CF, AOC and ENZ have gone south.

Traffic: K7QZ 2 CF 5 ENZ 5 BNW 10 VH 12 PQ 63.

IDAHO—SCM, Don Oberbillig, W7AVP—NH leads Section. BYW, DEB, CFX, AVZ have hamfest. KJ is on 3.9-mc. 'phone. EFL has new rig with 10s. DBP has been QRL fighting forest fires. BDX is forestry lookout. EKV has new Gross. DCG will try for Class A. EKX has Gross transmitter. BKK has PR10. DCG, EKX, EKV used 56-mc. rigs in hunt for lost game warden, near Mullan. BRU is 28 mc. AAJ was on visit to Calif. CHT increases power to 200 watts. DAW rebuilds 28-mc. rig. ASA likes beer and good schedules. CUG has new bug. EFB will rebuild. EQO, EOS: new hamlets. EFR lost trousers at ham picnic in Boise. DDU has trouble getting crystal to oscillate. DKY works DX with low power. EMN has new rig. EEZ is rebuilding shack. CAT builds radio shack away from all B.C.L.s. BCU, CGR are organizing 28-mc. Idaho net. BMF is reviving schedules. GU attends Gem State Amateur Radio Club in Boise. CSP, CZO have had schedule for over year. EPU has fun with Collins 30FXB. BZJ will increase power to 250 watts. CFX takes trip to coast. BAA, GL, DZO swing into busy A.A.R.S. season.

Traffic: WYNH 76 DBP 2 BRU 6 AVP 25.

MONTANA—SCM, O. W. Viers, W7AAT—FL is on again. DHW is moving to new QRA. BDS is active A.A.R.S. EDJ is QRL football. CPY returned from trip through Yellowstone Park. Anaconda: CME reports. EOX left for New York. EIH has new c.c. rig and FB7. EET, AOH have home-made bugs. EPX, EQP: new stations. AOH is QRL U.S.N.R. BJZ, AOD, BVI and CCR of Missoula are on.

Traffic: W7CME 33 FL 22 BDS 6 EDJ 4.

OREGON—SCM, F. L. Black, W7AMF—DTG holds first place. Our O.P.S. Net is working 100% due to nice work of P.A.M. AHZ. WR and CXK kept continuous schedule during heavy storms. HD is back from Alaska. QY took charge of radio shack on S.S. *San Lucas*. The memorial key of the late 7PL of Pendleton was awarded to 7CZY, Everett, Wash., as most outstanding amateur in N.W. Division. Rebuilding: DNP, HD, COU, BZS, BKD, MF, BUB left C.C.C. station WUBG for school. MQ had another serious breakdown. AXQ was surprised by visit from a 9 from Elmherst, Ill., who dropped in by plane. One of KL's new 830's went west. CFM left for job with Hickok Meter Co., Cleveland, Ohio. DP spent vacation on coast with CXK. KR and BEE attended Seattle Convention. DLH is proud possessor new Gross transmitter. GQ has brand-new baby boy. BGF says 1.7-mc. half-wave zepp can be put up in back yard. AGQ has new 1.7-mc. 'phone. BIO gets out FB on 3.5 mc. AHZ and WL visited the S.C.M. DIW announces publication of "grid leaks" will end with October issue. UJ of Eugene is new Route Manager. A.A.R.S. season opened with a bang on Sept. 10th. There are some vacancies in A.A.R.S. in Oregon. Any amateurs interested write officer in charge Radio Communications, Presidio, San Francisco, Calif., or your state net control station.

Traffic: W7DTG 362 COU 180 AXJ 139 (WLVP 16) MF 147 (WLVO 11) BUB 77 UJ 51 AYV 37 BLN 33 BGF 13 WR 12 AMF 12 KL 7 DDG-QY 3 SY-DAV 2 CRK-ABH-AHZ-ABZ 1 DP 8.

WASHINGTON—SCM, Stanley J. Belliveau, W7AYO—DGY leads Section for first time. CQI has several K7 schedules. AYO is back at college. WY is busy with Section paper. AFX was op. on tug . . . WJFP. LD is getting Trunk Lines fixed up. CCT worked PK3LC. DDO

is new reporter. EPT is building c.c. job. DPU is going to W.S.C. ALH is Alt. S.N.C. for A.A.R.S. CBQ reports by radio. AQ handled traffic from Yakima Fair. AW is new phone O.O. BRT is going to U. of W. AG's antenna took a flop. APR got new receiver. 1CLX visited 7VY; both are DX hounds, both have worked 74 countries and have W.A.C. Section bull coming along fine and met the approval of the gang. We could use a few more good O.R.S. and O.P.S. Those interested please write the S.C.M.

Traffic: W7DGY 526 CZY 502 CQI 289 AYO 262 WY 108 CSK 105 CPK 97 AFX 84 RL 76 LD 75 CCT 59 DDO 53 EKA 48 EPT 47 AZI 44 QI 43 DPU 36 APS 32 ALH 27 CQB-AQ 22 DRY 21 EAW 15 CAM 12 AW 11 CPF 10 BUQ-BRT 9 IC-AG 8 APR-AUR ECM 6 ELI-BBK 4 ECX 3 ENG/7-UE 2 IG-BOF-DZX-AHQ-BUX-AWF 1.

W7AZP traffic is from Clallam County Fair. W7AIT gets good reports from New Zealand using low power 20-meter fone. W7EFS was recently married.

Traffic: W7AZP 274 AIT 3 EPS 1.

PACIFIC DIVISION

HAWAII—SCM, A. O. Adams, K6EWQ—FJF is playing with antennas. ETF has new rig. AGI has new AGSX. LBB got married. Congrats, OM. DV is doing nice work. JPT is visiting with Schofield gang. EBR left for Kelly Field. JJP will be heard from W3DHZ after January. LCV and LGM are new calls.

Traffic: K6EWQ 2792 JPT 570 FAB 210 LBB 177 JRN 64 FJF 32 GZI 28 CGK 25 YAL 4 EDH 1.

LOS ANGELES—Acting SCM, Herbert Winslow, W6ILV—AUZ had visit from K6EWQ. BMC is moving to San Diego. EK (a YL) received A.A.R.S. call WLVK. HZT has new schedule, KA2JR. KBY won four prizes at ham banquet. IDZ is building new rig. CGE now signs "N" instead of "W." KZH finds DX FB. CVV says 7 mc. is getting better. HHZ is going to radio school. HZU/IOL/JZT is building transceivers for 56 mc. DWP is increasing power. KBF blew up perfectly good rig trying to put 2000 volts on 212D. KEI works lot of DX on 1.7-mc. 'phone. CAH is rebuilding rig for DZR. HDV is QRL radio school. HDC is QRL college. HEW received O.R.S. AIF reports from bed. Sorry, OM. KJE's kid brother got call KZI. GWO got himself a new car. Don't crowd, YL's, it's a truck. Hi. IJV has lots of fun signing "N" to his call. JXZ is playing with 56 and 28 mc. 6 BPU, our regular S.C.M., is on a much needed rest trip to Europe. He turned the S.C.M. job over to ETJ. Recently ETJ got a job which made it impossible for him to carry on. So he turned the work over to AUB. Now it is impossible for AUB to continue, so ILV has been given the job. Please keep reporting care of 6BPU, same address as before. Remember the deadline is the 17th.

Traffic: W6AUZ 642 BMC 590 CVF 385 EK 345 HZT 260 GXM 208 KBY 156 IJK 133 VJ 110 LDZ 108 IOX 96 BPU 56 FLC 31 AKW 38 CGE 28 UP 27 DNA 25 KZH 24 CVV-RHZ 20 HZU/IOL/JZT 18 DWP 17 FYN 15 KBF 13 KEI 12 CAH-GEX 11 BZR 9 HDV 6 DSP 5 ILV-JKH-GSL-HDC 4 HEW-JNE 3 AIF-CKR-GWO-IJV 2 KJE-IOL-JXZ 1.

SANTA CLARA VALLEY—SCM, Chas. J. Camp, W6BMW—This is first report from your new S.C.M. Many thanks, fellows, for your support. CUZ made cruise with U.S.N.R. AOF keeps 1.7-mc. 'phone going. HCQ holds down a flock of schedules. JDV has worked 18 stations on 56 mc. FQY is going back to school. HBB works c.w. 'phone duplex with GAV. BMW manages to get a little time for radio between forest fires. FBW keeps schedules. DHV is recovering from appendix operation. HTJ is chief operator at YU. CTM-FMM 7 mc. rig was heard in Germany. DEB has new set of rectifier tubes.

Traffic: W6CUZ 13 BFW 69 AOF 11 BMW 35 KOQ 1 DEB 7 HCQ 17.

EAST BAY—SCM, P. W. Dann, W6ZX—I regret to report that 6CIZ and wife were seriously injured by a hit-run driver recently, but am glad to say they both are improving rapidly. We all wish you both well. RJ is busy with A.A.R.S. GHD resumed schedules with AC2RT and KA1NA. EJA schedules KA1CO. JTV handled plenty of

P. I. traffic. HHM is consistent traffic man. ZX is still working Springfield, Ill., and east coast. Old-Timer 6CI sometimes acts as second op at ZX. IXY is a newcomer. AHI works P. I. consistently. DHS is with us again after death of General Strike. CGU is finishing new rig. IMI uses a '52. KNO is busy in college. ITH returned from A.I.-E.E. Convention at Salt Lake where he presented a paper on "San Francisco-Oakland Bay Bridge Construction Radiotelephone System." He and ATR are building 56-mc. transceivers for their cars. GHD will have 1-KW rig on air within a month. Following were visitors at S.C.M.'s: JVB from Salt Lake, AJP-KBZ from Reno, and GUR from Sacramento. Monthly meetings will commence immediately after the S.C.M. returns from vacation, Oct. 4th to 23rd inclusive.

Traffic: W6RJ 268 GHD 95 EJA 60 JTV 47 HHM 41 ZX 40 AHI 12 DHS 5 CGU 3 IXY-KWK 2 IMI 103.

SAN FRANCISCO—SCM, Byron Goodman, W6CAL—RH is on 56 mc. HSA is rooting for the Section. JDG worked ZL and J with '46 doubler. AWA and BGW combined station, worked 40 ZS's this month. SG is building 'phone. KNQ has new job on ship. LIE is operated by BRW and BUM. DO handles P. I. traffic. HRY is lining up schedules. HJP is chief op at YO. JYB is on 1.7-mc. 'phone. JZJ has new Sargent receiver. BIP was QSO Angola. KNH has new c.c. rig. JAL is doing good work as R.M. AZK is starting at U. of Cal. EKQ is putting in RK20. DDO is building c.c. 'phone. CWR reports start of U.S.N.R. branch at Eureka.

Traffic: W6ZG 1319 (WLV 284) RH 146 HSA 35 JDG 54 AWA 28 BGW-NK 24 SG 22 KNQ-JNI 18 LIE 21 DO 16 HRY 15 HJP 11 JYB-JZJ 6 GQK 7 BIP-JQJ-KNH-JAL 4 AZK 3 EKQ-DDO 2 JYU 1.

SACRAMENTO VALLEY—SCM, Geo. L. Woodington, W6DVE—Your S.C.M. is back on the job with a new skin. For the information of those not hearing about your S.C.M., I was caught in a gasoline vapor explosion in a pit and had all the skin burned off both arms and face, but I am about as good as new again now. I want to express my appreciation for the thoughtfulness of the boys who called while I was laid up. LGD and JYM are new Sacramento hams. KAF just moved here from Burlingame. KCA worked K7. KME has Tri-tet. IMV is dreaming about '03A. GZY is to be new president of Sacramento Valley Radio Club. GVM is now in Sonora. IMJ used to run a rock crusher in ye olde days. IZE is active on 3.5 mc.

Traffic: W6CGJ 13.

ARIZONA—SCM, Ernest Mendoza, W6BJF-QC—ALU purchased new V-8. QC is still at Parker with Army radio GW4. KOL is going heavy for traffic schedules. FZQ attended Santa Barbara F.R.C.S.C. meeting with DQJ. IQY is doing lots of work on 11-tube super. GFK revamped portable. IZU has '52 on air. KGQ got new 880's, new 866's, new car! DPS visited Phoenix to see dad, KKE. FGG had new 863 break in mail! IMR is going to 14-mc. 'phone. HBR and IIG like 3.5 mc. BFA schedules QG daily. IIF works for W.U. KFC was at Prescott for vacation.

Traffic: W6ALU 378 QC 70 KOL 51 FZQ 28 IQY-GFK 1.

PHILIPPINES—SCM, N. E. Thompson, KA1XA—ICO is on air again. P.A.R.A. meeting, August 27th at ISX had big turnout. New stations: IDD, CS, 9JO.

Traffic: KA1HR 1685 LE 334 US 298 NA 250 AN 208 SX 167 RC 136 CS 133 EE 115 FS 96 XA-HP 69 JR 52 TS 22. K4AGR 18. KA9WX 86. K6FKB 43. OMITB 118.

SAN DIEGO—SCM, Harry A. Ambler, W6EOP—FQU is working R.M. net daily. CNK works DX mostly. BLZ reports new Costa Mesa ham. LEG and CUS have gone to college. IQA has 1½-meter rig. FKT has been in Glendale. GOG and APC are back from fire zone. FY is on 1.7-mc. 'phone. LD has new crystal mike. BWI has new 'phone rig. DUP, EOO, BMB called on S.C.M. VQ is on 28 mc. ZQ will be on with high power. BOW was heard on 3.5-mc. C.W. QY works 14-mc. C.W. IBK, our 'Phone Activities Mgr., has new phone. The San Diego Radio Club meets every two weeks.

Traffic: W6FQU 114 BFK 87 CNK 18 BLZ 2.

SAN JOAQUIN VALLEY—SCM, G. H. Lavender, W6DZN—FFU is trying R.C.A. double doublet. EXH is building an addition to his egg factory. GQZ is again teach-

ing school. GXL got job as radio service man. DZN's storage battery exploded. GGM of Santa Cruz is now at Manteca, while attending junior college at Modesto. BXB has new rig. IKG has new Sargent receiver.

Traffic: W6EXH 35 DZN 28 FFU 12.

ROANOKE DIVISION

NORTH CAROLINA—SCM, G. H. Wright, Jr., W4AVT—The SCM urges every ham to please get report in no later than 20th of the month. The 1.7-mc. 'phone net, under direction of 1.7-mc. P.A.M. 4BYA, is going strong. The 3.9-mc. 'phone net is functioning very nicely. MR holds lead in DX work. Wilmington gang is getting up steam on 56 mc. Winston-Salem Club is holding an intra-crew contest within the club. N.C.S. 4ABT is getting A.A.R.S. net functioning. All A.A.R.S. stations will soon be on the same frequency, using the famous CCC crystals. BV, CXQ and BX have new 1.7-mc. 'phone rigs. DQ and VW have new receivers. BRT passed Class A exam. All hams within distance are urged to attend BIG North Carolina Hamfest in Charlotte on Sunday, November 4th.

Traffic: W4AIS 80 BRK 26 NC 24 CQB 14 BV 12 BRT 10 AOE 10 EG 7 CVQ 6 AAU 4 CYB BVD DQ BX BYA OG 2 CJM ZH CCH BXF 1.

VIRGINIA—SCM, R. N. Eubank, W3AAJ—3ENJ handled message to Gov. of Va. in two hours. ANT BPLs monthly on K5AA and K5AF deliveries. BUY has '04As in P.A. APT's new rig 47-46-10-30. BAD has FB A.A.R.S. Net for Dist. 5. ALF is now at Appomattox. CYM schedules EQJ, EPM. OM is on 3560 kc. EPK added pair '10s. ELJ is joining N.C.R. ASK QSP'd Morro Cattle traffic from ZYC on beach. BFW has phone on 1.7 mc. BRY is A.A.R.S. EVN worked X1BC. BZE uses 3AAJ vertical. ECQ is active in A.A.R.S. EVO is adding 212D. MQ schedules 2BYL. BEK is DXing on 14,190-ke. 'phone. COO schedules 4BHR, 9BBQ. DAM has new antenna. EOO has 71A going well. EPX schedules 3BAD, 2GOX. CYK was QSO W6 two hours on 3.9-mc. 'phone. DVO is adding 351 and FB7. BYA worked VK5LD. BIW says RK 20 FB. AAF enjoyed Winston Salem fest. CCU uses Tri-tet. JG blew power pack. CIJ never missed an OPS. party. AZU built s.s. receiver. ELC got married. Congrats. AKN is trustee for club station. AIJ has plenty of rigs. AII's new c.c. frequencies: 3530, 3878, 3645. AOT says club plans rig at fair. AVR says plenty of stations at U. of Va. BZ is experimenting on 1.7-mc. 'phone and 28 mc. BTR is on 14,070 kc. CKM is at Natl. Bridge C.C. Camp. DDA was in Panama five months. DEH has '59, '10, 211, on 7 mc. EOO reports regularly. ENO is on 7 mc. EQQ and EVG send first reports. ENR is operator at EGD. EMX is YF and OM station. 3GE has new tower. FE has Class A ticket. EEN has been on 56 mc. all summer. ECR took U.S.N.R. cruise to N. Y. C. DZW's 211 busted. DBI is Petersburg Club station. BWA and CPN are rebuilding. BSW broke foot. BPI attended Winston Salem 'fest. BXP is back at Ferrum. EBK is getting bugs out of new rig. DSH has com'l. first ticket and ham class A. AJA was heard in N. Africa on 3.5 mc. EHL is new O.R.S. EAI is QRL YLS. CQW is active. EBD and EDG want O.R.S.

Traffic: 3ENJ 79 ANT 247 FJ 45 BUY 16 APT 15 BAD 15 ALF 93 CYM 12 OM 12 EPK 7 (WLQD 7) ELJ 6 ASK 4 BFW-CZJ 4 CIE 3 AAJ 2 CA 2 APU-CQW 1 BJX 34 EEL 25 BEB 24 EPW 64 CSI 24 AEQ 18 CFV 13 AMB 10 EGD 8 BRY 7 EVN 7 BZE 6 ECQ 5 EVO 5 EUL 4 MQ 4 BEK 3 COO-DAM 1 EOO 1 EPX 110 CYK 18 DVO 3 BYA 295 ELA 10 APF 2 BIW 2 AAF 1 DCU 21 CCU 7 JG 1 CIJ 6 EDG 5 CPN 3.

WEST VIRGINIA—SCM, C. S. Hoffmann, Jr., W8HD—EIK resigned as R.M. of Southern District; he will be very much missed. KKG schedules NY2AB; he visited 3ASO, WLM and WAR. AKQ moving to Lumberport. HD visited Huntington gang. BKI says "RF is excellent in removing warts!" LSJ works all but W7s. LSK uses '47 self-excited. JJA, JCB, CHM, HIU, BKI attended Colum-

bus Convention. HBQ works VKs with Tri-tet. 8XAW, KIU, DSJ will be used from W. Va. Univ. EP has been on air 12 years, and just reported to S.C.M. first time! He is using 1912-cc. 'phone. GB moved to Pittsburgh. JWJ visited LAC and LIO. ELO had two week U.S.N.R. cruise aboard "NEPS." CDE is selling out for high power. MOZ was heard by ZL2HR on 3.9-mc. 'phone. EYV and KSJ visited 9USA. EZR is drilling panels for new '52 job. ADI announces the Navy Dept. will issue "NDE" to Wheeling, for U.S.N.R. work. Congrats, OMs. KWU schedules 6TI. New stations reported: Bluefield MOP, MOW; Grafton: MIT; Northfork: MOZ; Weston: MCJ; Wheeling: HWS was reassigned to HWT, to be used at Linsly Institute. FVU has new YL opr. Congrats!

Traffic: WSEIK 20 (WLHG 94) DMF 16 HWT 12 KKG 204 CDE 2 KWL-FQB 1 BDD 42 CMJ 8

ROCKY MOUNTAIN DIVISION

COLORADO—SCM, T. R. Becker, W9BTO—BYK has Class B '10s. FYY is in U.S.N.R. with BTO, BYY and Chuck Sibley. KGR returned from vacation in East. AAB is busy taking pictures. JB is on Navy drills, as is FA, and GVN. HQT is on 14 mc. CWX is adding pre-selector to PR-10. CND is on in early A.M. BJN has been running his Ford to death. FNM (X9DLM) is on again. BVZ is on 3.9-mc. 'phone. GLY and HQV increased power. IKA is on 1.7-mc. 'phone. EMU has '03A's Class B Mod. GJJ finally found a house. LYE is in Texas. EKQ and CDE keep A.A.R.S. on map. HRI uses Tri-tet. HIR has FB 'phone. 9YL sold FB7. EHC will soon have 10-tube super. GNK has FB bunch of schedules. MFP and JRV have c.c. PGS worked K5AA and TI2KF. IPH will be on 14-mc. 'phone. PVZ is on regularly. 9DDF has trouble getting started on 1.7 mc. Rebuilding: CBU, PWU.

Traffic: W9PGS 3 PMF 9 GNK 194 CDE 4 EHC 2. UTAH-WYOMING—SCM, Arty W. Clark, W6GQC-IDM—Utah: W6KDI leads in traffic for first time. FAE is all set for N.C.R. CNX is at Calif. Tech. for last year. HVU and JYD will attend U. of U. FBY is at WVX in C.C.C. BLE is rebuilding 'phone. New 56-mc. equipment at GPJ. DGR is taking over Unit One in N.C.R. DEM is out of job. JVB went to Berkeley and was QSO S.L.C. from LXY, Wyoming: W7ARK may have new power line. AEC moved. DIE fought mud on road home from W.I.M.U. Ex-BVJ is in Seattle, Wash.

Traffic: W6KDI 168 GQC 67 FYR 39 KKG 19 AFN 15 GPJ 9 JVB 3 FAE 2 DTB-DGR 1. W7COH 39 AEC 10 DIE 2 CSE 5.

SOUTHEASTERN DIVISION

ALABAMA—SCM, L. D. Elwell, W4KP—BJA leads state with traffic. RS, on both phone and c.w., is A.A.R.S. N.C.S. APU joined A.A.R.S. BRX is in A.A.R.S. BOU has new rig with 100 watts input. ANT is building Tri-tet. ADI is on in Sheffield. CWB is reporting to Marion Military Inst. BGO has 'phone well under way. BBO reports via radio. GL expects to be transferred to Jacksonville, Fla. BLI, OA, CNI, CRF and CQV are back on air. GP has new s.s. receiver. The Alabama Deep Sea Rodeo went off with a bang so far as Mobile gang were concerned. CQV (portable) and BLL provided communication between the island and the mainland. Excellent results were obtained and officials of the Rodeo will include it in program for next year.

Traffic: W4BJA 42 APU 17 BOU 16 BRX 9 KP 7 ADI 6.

EASTERN FLORIDA—SCM, Philip A. McMasters, W4BCZ—FM and RU have been experimenting with 56 mc. DU is going strong on 3.9-mc. 'phone. HY's antenna rope broke. BFR, AGB and NN are rebuilding. AWE raised power to 120 watts. ANY has new commercial ticket. AIJ works hard at police radio station. CWR applied for O.P.S. CQZ, new P.A.M., has taken over control of 1.7-mc. 'phone net. CSJ worked all W and VE districts with single '45 excited by 24 e.c. osc. COV replaced '10 with '46 Hartley. DBO, DAP, DBG, DBA,

CZZ and DBF are new St. Pete. hams. St. Pete. A.R.C. had a hamfest Labor Day. Following won prizes: A.O.Z., ANE, CSJ and DBG. APY passed Radiophone first. BNR handles lots of traffic on 1.7-mc. 'phone. NB is chief operator for Pan-American Airways. CQJ has new Class B modulator. AKA visited 9USA. CSH schedules K6DV. AZB has new RK20 transmitter. DE is working VK and ZL. DZ is building c.c. rig. ALT is back from vacation. BOT has new McMurdo Silver receiver. CZS is building 1.7-mc. 'phone. AJX is constructing new sky hook. BNI on 3.9-mc. 'phone has schedule every Friday with 1.8-mc. 'phone for emergency tests. Try more cross band QSOs, gang, they are FB. DDR, St. Pete.'s newest ham, saw call in the paper before he got his ticket. Hi. CQD will enter Jr. College in St. Pete.

Traffic: W4COV 4 BRA 6 NN 25 FM 13 AZB 10 AGB-BIF 7 DE 5 AOT 4 BCZ 14 CSJ 10 CWR 2 CQZ 8 AJX 13 AWF 15 BOT 2 CTS 5 BNR 24.

WESTERN FLORIDA—SCM, Eddie Collins, W4MS—RM's: 4ACB and 4AUW. UW was visitor to the home gang. BSV-5ZZR is now a W3. BSJ may change QRA's. BPI returned to U. of F. CTZ is holding fort in Perry. CWF moved. AXP, CQF, AGS and ART are active on 3.5 mc. AQY has been QRL state highway. ACB toured the Section. QR is on 7 and 3.5 mc. DAO is working DX. COG is QRL football. QU uses new "N" prefix. BFD has Collins antenna tuner. BGA is rebuilding. ASV is going to Haiti during U.S.N.R. cruise. QK and BCB are regularly on 7 mc. CTA operates NAS all day. CSR is having battle with rig. AUW is rebuilding with Collins data throughout. BKD has gone to Ga. Tech. AUV plans new layout. CDE is adding pre-selector and crystal to super. 6VN was welcome visitor at MS. 9IAW was visitor to Pensy. BDL is one of newest calls in Section. CRU has new power pack. COG is going to paint top of MS' 65-foot tower!

Traffic: W4AXP 14 AUW 6 AGS 3 COG 2 VR 8 ACB 4 QR-CTZ 2 MS 11.

SOUTH CAROLINA—Assistant SCM, Bannie J. Stewart, W4CE—ADE opened radio store in Spartanburg. AIF is with Coast and Geodetic Survey in Miss. ANK is back from a Ga. Beach where he was member of an orchestra during summer. ARH hopes to have Spartanburg Club going again. AZT is experimenting with 'phone. BCY is joining N.C.R. BDT is starting traffic schedules. BJC and JT are back at Clemson College. BNN is on 1875-ke. 'phone. BQM is in charge of Unit 1, Section 1, N.C.R. of Sumter. BZX is going to 3.9-mc. 'phone. CE Commander Section 1, N.C.R., 6th Naval Dist. CHD says strike kept him busy. CIR was on strike duty with N.G. CQG is building new receiver. MN is head of Physics, Univ. of S. C. VL wants to get rid of 75-watter. CPZ shot transformer feeding 1-kw rig! CQJ is student at Ga. Tech. CYG needs a receiver badly. CWY is going well in Charleston on 7 mc. CXU is new in Bennettsville. BCN has FB 1.7-mc. 'phone. DAM has May QST 1.7-mc. 'phone. CUS is teacher in Medical College. CWT and CWP are new in Greenville. DCV is Unit 1, Section 1, U.S.N.R. station, Sumter. AFQ wants schedule with S.C. hams on 3.5 mc. Anyone wishing list of S.C. stations write to W4CE.

Traffic: W4BDT 24 BZX 8 CE 3 AFQ 30.

K5AF/WZAL during Aug.-Sept. month orig. 98, del. 59, rel. 3, total 160.

These reports sent in by George A. Love, W4UT. Cuba: CM2SE has the DX record on 'phone with two 46's in parallel final. CM2WZ comes next in DX and skeds Sam and Mac. He has a new Paterson. CM2RA has added an 830 final. CM2QY got his rig going with a gold seal crystal. No more complaints from CM2AN. CM2SV has changed to Class B fone and thinks it not so hot. CM2AN expects to get out with the RK20 on C.W. CM2NA has quit. CM2FA has nice DX every day with Europe. W4UT honored CM hams with his visit to Havana. You are always welcome. CM2GR was re-elected secretary of the Shortwave Club. CM2MA has gone to Mexico and works CM2SE. CM2DO has a new xtal rig on 40, and works DX on 20. FB, OM. CM2OP

now gives WX rpts. from his OM observatory. CM2WW has his C.W. rig perking and doing DX with Europe. CM2RA and CM2SE foned a plane 1500 ft. in the air thru W3XZ flying over Phila., all remote-controlled; they were tickled to death. Puerto Rico: K4SA continues active on 14-mc. 'phone. K4AOP, building xtal rig, active on 14 mc. and 7 mc. K4RJ, busy at WGT, has a new Comet Pro. K4CVV moved to Santurce from Humacao. K4UG sold out to K4AOP, now planning new station. K4KD active on 14 mc. when not at WMDU. K4ZK is building a station at Ensenada, K4KD's old roost.

WEST GULF DIVISION

NORTHERN TEXAS—SCM, Glen E. Talbutt, N W5AUL—BII Chief R.M.; ARS, BKH R.M.'s; SP P.A.M. BII has new Tri-tet. AW is in race for traffic prize. DXA QSO'd KAI. CPB is now movie "op." EES wants O.R.S. EEF reports EFC back on air. BXA makes first report. CHJ went to the fair. ZD is back after long illness. NW is winding up his campaign for Director. DUR has new PR-10 "sewing machine." ARV has W.A.C. DM is on with new rig. ABW is still trading. BCW has 500-foot receiving antenna. EIM's QRA is Dalhart, not Dallas. DAF reports CRP moved to So. Tex., CRF QRL. COK has Class "A." AJ has been traveling around with portable. CF Jr. visited S.C.M. AUL has new rig with pair RK-20's final. AW, AUJ, BXY and AZB are going to H.S.U. in Abilene. DXE is going to school in Abilene. ARS was on Navy cruise. Every good amateur station interested in traffic work should be an O.R.S. Also want more O.P.S. and O.O.'s.

Traffic: W5CCD 217 BII 128 AW 81 DXA 73 CPB 43 EES 37 EEF 24 EEW 23 BKH 15 BXA 14 CEJ 12 NW 10 DUR-ARV 2 CPT 1.

OKLAHOMA—SCM, Carter L. Simpson, W5CEZ—CEZ is QRL with WX reports. BQZ has trouble with juice going off on A.A.R.S. drill nights. The wind blew BKK's antenna down. BJG enjoys working in WX reporting net. BAR succeeded in getting kid brother in shape to get ticket; the relief opr. signs EME. DTC enjoys A.A.R.S. EEP is Pre-Med. student at U. of Okla. BDX enjoyed World's Fair. CJZ has FBXA. BWN spends most of time repairing B.C.L. sets. YJ has operators since school has started. DDW applies for A.A.R.S. EMH's QRA is same as BAR. AVE has new junior operator. Congrats. OM. New O.R.S.: AMT, AJF. New A.A.R.S.: BLJ, DZU. ATB has new rig. EMI is new Pawluska ham. AIR is taking much needed vacation. Lightning struck ABK's antenna. BCS is rebuilding. ASQ is chasing bugs in new rig. BIM is going to school in Port Arthur. AOW left to attend M.I.T. CFA is moving to Ponca City. The Ponca City Key Clickers postponed hamfest until spring or early summer.

Traffic: W5CEZ 768 BQZ 198 AMT 134 ASF 130 BKK 96 AJF 59 BJG 77 BAR 56 DTC 34 EHP 32 BDX 31 CJZ 22 BLJ 21 BWN 20 YJ 17 DZU 11 COA-DDW 8 EMH 6 AVR 4 BVK 3.

SOUTHERN TEXAS—SCM, Bradfield A. Beard, W5ADZ—OW keeps DX traffic schedules. MN has eleven traffic schedules. DWN is new O.R.S. MS says Corpus Club has new storm building and emergency equipment. BWM is DXing. EBU and EMR (W9IGX) are O.P.S. EJW uses '45s P.P. EKJ and EJZ are testing on 28 mc. DPX is live wire P.A.M. EKN DX's with '45s. CD is joining Navy. AXO will be W3 before long. EFB visits in Missouri. BHO sports new V8. BZW has her W.A.C. BNJ reports for CWD, AFN, BOD, EBS, DVL, AEC, BQU, AOT, DCO, and AEP. AFV and CUJ worked VQ4CRP. ADZ and BUB are going to Rice Institute. AEK works 14-mc. 'phone DX. Active: DSP, DUQ, ABH. Wanted: applications for good live wire O.R.S.1 Also want good O.O. and Chief R.M.

Traffic: W5OW 435 (WLJ 685) MN 343 DWN 79 BFA 58 BJ 55 BEF 38 MS 16 BWM 5 EBU 4 EJW-EKJ-EKN 1.

NEW MEXICO—SCM, Dan W. De Lay, W5DUI—CVB reports after one year's vacation in east. DZY

visited ZA, ZM and CQL. AAX plastered wall with W.A.C. certificate. EAO put up Class A ticket. AQ and AOP are collecting parts for new transmitters. CSR is figuring on 'phone. Say, gang, how about a couple contests, say DX and TRAFFIC? Any ideas or suggestions will be appreciated. 3DMJ from W.N.Y. is now 5ENI at Lovington.

Traffic: W5DUI 7 DLG 42 CJP 8 AAX-DZY 1.

CANADA

MARITIME DIVISION

NOVA SCOTIA—SCM, A. M. Crowell, VE1DQ—EX had solid 30-min. QSO with "CE." FT applied for O.R.S. AX, DC, DQ are completing new rigs. EP and FN are combining outfits. GE schedules W4UP on 14 mc. GB entered the ranks of the benedictis. HH has all-band c.c. with YL as 2nd op. HK and AJ are new Halifax calls. AO, AJ, BO, BE, CL and FS report swell time at hamfest at Bar Harbor, Me. FB's new SW5 helps the DX. EG is on 3.5 mc. with '01A. GC is QRL telephone work. 1GH has new rig on 3.5-mc.P.P. 11's running at 225 watts.

Traffic: VE1EX 8 FT 7 GE 3 GH 3. VOSW 2.

ONTARIO DIVISION

ONTARIO—SCM, S. B. Trainer, Jr., VE3GT—The Ottawa A.T.A. had large picnic on Labor Day. Prize winners were: 3JE, MX, XQ, WY, LI, SA, 2BE, GP, with 3AM and MB locating hidden transmitter. 6N turned out for Hamilton Club picnic at Grimsby where 3KM and SP put on nice 56-mc. show. NO, SG and WK are doing nice traffic work. DJ and AU came forth here opening of school. QM got a sickness message through to N.Y.C. and back via AU in forty minutes. EM claims his 1111th QSO. IG claims Ontario record, having recently QSOed 41 VKs and 30 ZLs. OX, RL, and GT are golfing? UU aided 9CNE by lending his transmitter. RB and NM applied for O.P.S. AZ is Ontario's first O.P.S. Rebuilding: DE, QN, RM. EA would like the 40,000-mile trip his VK5 card had. PO helped 9CNE. TM is on again with traffic; LS, HQ, and DU are after more. Summer entertainments keep IB QRL. W2OT visited MB; 2EYY visited ER; PX, GH, UJ, YW visited NC. SM and other Forestry ops are glad to be out of the woods. SE moved. PM sells cosmetics. CF has been busting crystals. QK visited 9USA. SZ is c.c. LN turned photographer. Looks like a good season to HP. JV has good 3.9-mc. 'phone. IH is back. An Army-Amateur Net for Ontario has been proposed. The following either operated or were present at 9CNE: W8LLI, CIE, AVI, JRW, DRL, EDI, VE2GR, VE3IQ, IB, AU, FS, DE, UM, NB, JT, YZ, GT, GF, AA, WY, CM, NX, ZR, ER, XR, LR, AZ, UJ, WW, QU, YB, CN, JO, EU, LK, NM, MI, WS, PX, IX, IM, GE, WT, UU, LL, SG, WK, NO. Don't forget the last Sunday morning in each month for the Ontario QSO Parties.

Traffic: VE3JT 244 NO 218 DJ 201 GT 125 IQ 125 AU 103 WK 54 IH 30 SG 29 IZ 14 IB-SM 13 PO-MB 8 NM 7 JO 6 HP 3 NC 6. VE9AL 12 CNE 317.

QUEBEC DIVISION

QUEBEC—SCM, Joseph A. Robertson, VE2GA—Montreal Radio Club and South Shore Radio Club started up again. C.G.M. (2BE) and S.C.M. (2GA) visited M.A.R.C. on opening night and were honored by being made Honorary Members of the club. Under the direction of 2CU, the Quebec Division A.R.R.L. had an amateur exhibit in the radio and electrical exhibition. Please advise the R.M. of schedules maintained. Nice letter from IT, our newcomer. HK, our O.B.S., will broadcast on 3592 kc. (C.W.) on Tues. at 10:15 p.m. AC is going to take active part in 28-mc. tests. DR schedules 3NO, Toronto. DG writes report standing up against telegraph pole. Hi! HK has "Comet Pro." HM is on trip to Europe. New rig at DU. W8DGV visits HK, DG and HT. AL does lots of flying. CU is home from Antiochi. BB visits Montreal shacks. AP deserts pound-

ing brass for catching pounds of bass. HP hooked first "G" with '45s. GO qualifies for O.R.S. HH is active at Back River. CG divides time between traffic and car riding. BG put up new sky-wire. BU visited Hartford and WIGKM. DU moved to new QRA. CX tried getting out without power transformer. BK's mother thought QSO with S.C.M. too long, so that finished that. CA wants portable 'phone to work Mrs. CA while on fishing trips. EE awaits card from UINP for W.A.C. CO is adding another stage to rig.

Traffic: VE2IT 4 AC 11 DR 66 DG-HH 12 BU 53 CG 9 GA 8 EE 2.

VANALTA DIVISION

ALBERTA—SCM, J. Smalley, Jr., VE4GD—Traffic records were broken due to booth in Vancouver Exhibition flooding the Province with messages. KG BPL's on deliveries. BZ's total is highest ever made in Alberta. NC broke all Alberta records for handling traffic on 'phone. QX handled all his traffic in 10 days! OG and AF handled most of the relaying with BZ while LK and HM did plenty of delivering. NC is the first Alberta station to work ZL on 3.5 mc. JJ is dubbed "Jessie James." EA has a Collins network. SD is c.c. on 7 and 3.5 mc. BW is on 3.9-mc. 'phone. HQ and JK are new O.P.S. EY jumped off the bridge! EX is back from Portland. FR is installing crystal in his super. EO has a Patterson. DX rebuilt his modulator. LA and CW have new junior ops. LX got in on the heavy traffic.

Traffic: VE4KG 239 BZ 421 OG 170 AF 156 QX 136 HM 49 LK 25 SD 5 DX 4 NC 115 LX 119.

BRITISH COLUMBIA—SCM, R. K. Town, VE5AC—Greetings. This month brings a record report from this Section! Heavy traffic totals are due to a station installed at the Canada Pacific Exhibition. BN, KN, EN, W6ENV, 6FKC, VE4CI, 5GT all visited the S.C.M. 'Phone activity is on the increase here. Many 'phones are handling traffic. BC, Ex5AD, GF, GS, AL and DD are on 56 mc. AG is QRL commercial operating. HF resumes 3.9-mc. activities. FT blew a transformer. HW is QRL apple picking. LI and XYL are busy on code and code book practice. AC reminds all of the A.R.R.L. official broadcast on 3.5 mc. every Wednesday at 8 p.m. EU goes back to college. EG has c.c. rig going. BJ handles traffic on 3.9-mc. 'phone. CA did nice QSP work for exhibition. CK was station at Vancouver Exhibition. KB has c.c. ready. JU operated at exhibition station. CD nearly made silent keys in 'phone pole tangle. GS is getting ready for 56 mc. IC is taking schedule for chess player. IQ made BPL (also made it last month and forgot to report). GJ took heap to summer camp. GI is rebuilding for winter. IN spent summer at Y camp. JE's dad is commercial operator. DW reports via BJ. ER has lusty 3.9-mc. 'phone sig. AL specializes in long-hop QSP. AM gets out well on 14 mc. with low power. BK handled exhibition traffic. FM sports new receiver. KN has new crystal on 1993 kc. BC does good work on 56 mc. BI has reliable DX contacts. BY is on 3.9-mc. 'phone. CV operated from Y camp and helped exhibition.

Traffic: VE5EU 326 EO 151 EG 50 BJ 180 CA 412 CK 1804 KB 225 JU 3 JF 62 CD 123 GS 64 IC 10 IQ 577 EP 171 HQ 318 GJ 322 GI 26 IN 58 JE 79 DW 28 ER 47 AL 43 AC 318 LV 268 AM 280 BK 78 FM 86 JA 54 KN 38 BC 9 GU 226 BI 29 BY 21 CV 40.

PRAIRIE DIVISION

MANITOBA—SCM, Reg. Strong, VE4GC—AG and NI keep good schedules. MW is new R.M. AE gets out on 14-mc. 'phone. MF is trying 56-mc. 'phone. IT has new receiver. NW has power leak. KX is new O.P.S. HZ and HP are rebuilding. DZ will have 860's final. CD says Collins coupler FB. BG puts out swell signal. MJ was a visitor. IU and DJ are chasing DX. KU has 50-watt final. MV and GL work duplex. TV, GC, RO, LH, KY, IA and RF are active.

Traffic: VE4GC 56 AG 36.

SASKATCHEWAN—SCM, Wilfred Skaife, VE4EL—JV is working oodles of DX: he would like to hear from

anyone hearing or working Africa. ND has his O.R.S. CV is DXing. JG is going to erect new masts. MH is back on traffic route on 3.5 mc. BB and HU are going to join the Benedicts. New ham at Biggar: TX. EL spent holiday at Manitou Lake. BF gets R8 from Japan on 14 mc. FW starts well as traffic man with fine total. Our R.M., GR, handles lots of traffic. Do not forget our get-together each Sunday on 3.5 mc. Let us make this season the best yet!

Traffic: VE4CM 239 GR 113 FW 105 ND 53 CE 50 EL 25 EH 11 ML 15 AV 1.

LATE AND ADDITIONAL REPORTS

W3ZI operated W8GHY with the 112th Field Artillery.

Strays

VE3AAY finds the Type 89 tube well adapted to suppressor-grid modulation for low-power 'phone work. Because the control-grid lead is brought out to a cap at the top of the tube and good screening results from the structure of the elements, the grid-plate capacity is very low so that neutralization is unnecessary, at least on the lower amateur frequencies. VE3AAY uses 750 volts on the plate, 150 on the screen, and biases the suppressor grid 90 volts negative. Four of the tubes were used in parallel, giving a carrier output of about 18 watts. The audio driver was a 41. Canadian hams will find the spray-shielded tubes especially suitable for this type of work.

A clipping from W4AKJ reports that the F.C.C. has granted WDBO permission to operate with a power of 750 watts at night and one kilowatt in the daytime!

Another bad break—the mail-order all-wave receiver guaranteed to tune from 1.5 to 28 megohms!

There was some QRR work at the Northwestern Division Convention, and 56 mc. came to the rescue. As Director Gibbons tells the story, W7BWW was on the Eagle Boat during the cruise to Key Point, and W7GT was playing around in a small speed boat, both with five-meter equipment. About half way to the locks the chief cook (what is it you call them in the Navy?) discovered he had left the coffee on shore. W7BWW called and worked W7GT, giving the cause of all the stir aboard. W7GT went back to the harbor, secured the coffee, and returned before the larger boat was through the locks. The gang had coffee with their sinkers, and the honor of the Northwestern Division was saved.

Those thinly-shielded meters with small magnets should be mounted well away from any power transformers. The field around the transformer will quickly demagnetize the meter and make it useless.

—W2GNX

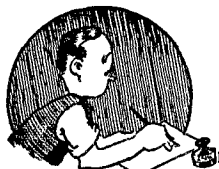

CORRESPONDENCE

The Publishers of QST assume no responsibility for statements made herein by correspondents

Automobile QRM

512 N. Main St., Wheaton, Ill.

Editor, QST:

Many amateurs are being troubled by automobile ignition QRM, particularly on frequencies above 7 mc., but, as far as I can see, nothing is being done about it. At the present time, due to the production and advertisement of "all wave" broadcast receivers, and the tendency in many cities to use 40 mc. for police radio, permitting two-way work, it should not be difficult to organize a campaign to cure the trouble. We might strive for the following:

1. To cause auto manufacturers to put suppressors on every pleasure car and truck.

2. To have cities and/or states require suppressors on each car or truck which is given a city vehicle license or a state license.

3. To request legislation in cities, states, or in the federal government, first, that every new auto sold shall have satisfactory suppressors, and second, that old cars shall have them installed.

My personal opinion is that such a campaign would be much more certain of success if the amateur would place little emphasis on reduction of ignition interference to amateur communication, but would use some of the following methods:

1. Propose to "short-wave listeners" clubs, or organize such clubs among BCLs and propose that they take some action.

2. That the police be approached on the idea that even if they do not now have high frequency police radio, it would be advisable to work toward elimination of this type of interference over the next few years in case such a system should become desirable; and also because it would clean up BCL interference.

3. Propose to city councils that BCL interference be reduced by requiring new cars sold to carry suppressors and even that old ones licensed annually be provided with suppressors; emphasis might be placed upon the attractiveness of the town to "SWL's" who might prefer it to neighboring towns if interference is eliminated.

4. Similar proposals might be made to state and federal congressmen.

5. Numerous letters could be written to the several auto manufacturers requesting that new cars be supplied with satisfactory suppressors, pointing out the sales value in the fact that not only is radio interference to an auto BCL set removed, but such noise is reduced for other auto

BCL sets and for SWL's in the neighborhood thru which the car passes. The cost per car would be only a few cents.

6. Radio manufacturers might also be influenced to join in eliminating this type of QRM to aid in future sales of short wave receivers.

I think that the amateurs can not only cure some very serious QRM over the next few years by taking up such a campaign but can also do a good deal for the BCL's. I therefore suggest that radio clubs, individuals, and the A.R.R.L. take up this campaign immediately.

—Elmer H. Conklin, W9FM

EDITOR'S NOTE.—A.R.R.L. has been engaged in a campaign in this direction for more than two years, cooperating with automotive magazines, manufacturer's organizations, etc. Result: Approval and offers of cooperation from automotive trade journals, the joint committee of the RMA and SAE, and others; indications of interest from various of the larger car manufacturers. Several producers have already taken major steps in this direction in 1934-35 models. At its 1934 meeting the A.R.R.L. Board voted to call upon the F.R.C. to take such steps as are possible to eliminate automobile ignition interference. Result: F.C.C. is currently preparing a plea for the attention of the automobile industry on this subject, pursuant to the Board's request. Remaining problem: Clearing up noise from several million older types of automobiles now on the road; an educational program, such as is partially outlined above, is probably the only feasible solution.

Gain

U. S. Naval Academy, Annapolis, Md
Editor, QST:

I am writing you to tell you a story. . . .

Yesterday Mr. L. C. Herndon, the radio inspector for the Baltimore District was at the Naval Academy giving examinations for operator's licenses. I was helping him check over the papers as each man finished writing. One of the fellows had drawn the question, "What is a gain control on a radiotelephone transmitter?" The answer as written was, "Gain control is the law which prevents an amateur from taking money for transmitting messages."

And if you think that I'm drawing the long

how, you have merely to refer to the examination of
dated 24 May at Annapolis, Maryland. . . .
—C. C. Butterworth

Contest Rules

417 Main St., Laurel, Md.

Editor, QST:

A diversion that was once enjoyable becomes a sadly dishevelled object . . . when the periodical DX Contest rolls around.

Such contests, and also the Sweepstakes, would be OK, if it were not for the fact that there is no justice for those who enter them. During the stretches of time taken by these contests the conditions might be likened to the old days when the lid was taken off amateur restrictions and King Spark rolled back into being. The air echoes with the bellow, the rasping and the musical tones from various types of signals. . . .

If such contests must be kept going then why not have them under contest rules that will put the gang on an even footing. Limit the power, make it necessary that signals of T9 quality be used, those of the contestants who are logged as being out of bounds of the limits of the rules be disqualified. . . .

Of course there are various tastes to be catered to in the game, but at the same time there is a sportsmanship that should be incorporated into it but is sadly lacking. The glaring selfishness is only too obvious in the case of a number of the bunch. I could mention a W1, a W4 and a W9 that were going to extremes a short time back. . . .

What say to the application of a good remedy to the contests so as to render them less objectionable? They only go to prove the old statement to the effect that, "It doesn't take much to amuse the children."

—R. P. Austin, W5EVA, ex-W2AMT,
W2AKC, W4BRO and CM2FN

More 'Phone Frequencies

506 E. 43rd Ave., Vancouver, B. C., Canada

Editor, QST:

The B.C.A.R.A. gang was entertained recently at a hamfest by an interesting talk delivered by Mr. A. A. Hebert of A.R.R.L. headquarters. During the course of the evening the subject of 'phone and c.w. frequencies was broached. When asked why the 75-m. 'phone band could not be extended to reduce QRM, Mr. Hebert's argument was that, according to observation, approximately 75% of the signals in the 3500-4000-ke. band were c.w., hence it would be unfair to extend the 'phone band. Now it is generally agreed that the QRM situation in the 3900-4000-ke. 'phone band is "umpty-ump" times as bad as that in the 3500-3900-ke. c.w. band, hence many would-be 'phone men are discouraged from attempting 75-m. 'phone work, thus accounting for Mr. Hebert's apparently unbalanced figures. Now I am sure that the c.w. men would not object to a little experiment. The suggestion has been made that A.R.R.L. get the frequencies from 3800-3900 allotted temporarily (for six months or so) for combined 'phone-c.w. work; that is 'phone men would be allowed to use from 3800-4000 ke., temporarily, while the c.w. men would still not be excluded from the 3800-3900-ke. area.

I am not a 'phone man, but some day hope to try 75-m. 'phone, and, while this suggestion comes from a Canadian, I am sure that if this experiment were tried and proved successful in reducing 'phone QRM in the United States, Canadians would also be allowed this privilege.

—D. G. Murphy, VE5EU

Beginner's Code

Mesquite, Texas

Editor, QST:

I have been on the air for just a week. W5EJJ is my call. I have made only a few calls and have worked three sta-

tions: 'BAR, 'EIH, and 'CWB. All were worked in the day time on 80 meters, and I'll tell you why, and I'll bet that you will favor my "beginner's code."

The first night I had my ticket I answered several CQ's, and a W9 came back at me with such speed that I didn't copy a word. I asked him to QRS which he didn't. I heard him CQ'ing again.

Well, at first it made me sore, but after I thought it over I changed my mind.

Most hams have only a short time each evening in which to work. They just don't have time to fool with a beginner. I also realized what poor ops we beginners were—couldn't copy ten per solid, much less fifteen per, which most ops use.

So for the next few days I worked to improve my ability so I wouldn't be such a pest. My copying speed jumped from 9 w.p.m. to 18! I became used to ham procedure. I read the chapter on operating a station in the Handbook several times, and would sit with the power off the rig and pretend I had a QSO.

The next time a station "came back" at me it was a different story. I copied him well and managed to send with only a few blunders. W5BAR was very kind to me. My next QSO was with W5EIH. I could tell I was getting better, for I made but a few mistakes. When I landed W5CWB I don't know of a single error I made. He told my father I did well and I knew I had. Now I know I am far from perfect, but I am now the kind of an operator that one wouldn't mind working too much. All my calls were made in the day time because then they are usually not very hard to get and they are, on the average, not too busy for a beginner.

Here is my "beginner's code":

1. Call when only a few stations are on. It is better for everyone.

2. Never call a station that you can't copy. You will probably be so nervous that you will have to ask for a QRS even though you could copy him solid before you hooked up with him!

3. Know what to do when you hook a station. Besides reading the Handbook, practice before a dead key, and be able to copy at least 15 per if you can before the first QSO. Copy all you can, and get used to it.

4. Don't say "CUL 73 OM" the first thing. Chew the rag as long as you can, because those first QSO's are very valuable. Actual operating experience is what a beginner needs. If you find someone who will chew the rag take advantage of it.

5. Give them a good honest signal report and your QRA the first thing. Know what a QSA5 R9 sig is! As you listen on the receiver to various stations pretend that you would give them a report.

6. Thank the other fellow for his time and work and send him a QSL card as soon as you have some printed. It's no fun to work a beginner. The other fellow had much rather have a snappy QSO with an old-timer—and can you blame him?

If beginners will adopt this code for their first month on the air there would be no need for the plan of placing the beginners in one part of the band by themselves, which I noticed in a late QST. Don't you agree with me?

—Robert L. Tosch, W5EJJ

Restrict 7 Mc.

23 W. 62nd St., Kansas City, Mo.

Editor, QST:

This is just another letter yelping for a restricted 7-mc. band. But—this letter contains the yelps of the delegates to the Missouri convention that was held last week. I am enclosing a petition which has been signed by a number of the fellows at the convention. . . .

At the C.W. round table 90 percent of the fellows were in favor of a restricted forty-meter band. Nearly everyone thought that an examination should be passed by all operators on the 7-mc. band. A minimum of twenty words per minute would be the code requirement, and such technical questions as would lead toward better operating would be asked. This band should be open for DX and message han-

(Continued on page 60)



Great interest has been aroused by the work on the 60 MC DX beam transmission described by Ross Hull in last month's QST. We feel this enthusiasm is not misplaced for it has been rather definitely established that the results obtained were entirely due to the use of directional antennae, and not to freak conditions.

For well over a month our experimental station, W1HRX at Middleton, Mass., has been in daily communication with W1AL at West Hartford. During this time we occasionally switched to a carefully adjusted conventional Pickard antenna system. Invariably, the

result was to reduce our effective range to 35 miles or so. Many local stations of far greater input power also attempted DX work with conventional antennae and also, generally speaking, were unsuccessful except under freak conditions. In an attempt to improve results, some amateurs increased the height of their radiators with rather disappointing results. Some others also resorted to overmodulation and invariably lost so much in intelligibility that their effective range was materially reduced rather than increased. At W1HRX we seldom used more than 60% modulation and never over 100 during these tests.

We have been amazed at the effectiveness of the beam. The explanation, of course, is that the use of a directive antenna system results in a power gain of about 20. Arrays similar to those used for transmitting are also equally effective for receiving. It is readily possible for us to hear distant stations when using the beam antenna that are completely inaudible on the conventional type. Perhaps one of the most impressive results noted during the experiments was the numerous occasions on which signals of W1AL were actually stronger at W1HRX than those of any local amateur station, even though some of the local stations used considerably higher power. W1AL reported noticing the same condition with regard to reception of W1HRX's transmissions at West Hartford.

A few random observations noted during these tests may also be of interest. Success or failure of a directive antenna array depends to a very marked extent upon the degree of accuracy with which it is constructed. An original temporary antenna put up in a hurry one evening with rope and broomsticks and suspended with quite a catenary between two trees performed but very little better than the conventional di-pole. The same radiators and reflectors when mounted in the rigid frame work of 2 X 2, as shown in one of the illustrations in last month's QST, performed in radically different fashion. The beam antenna is also highly directive, and it was found that a change of but 12½ degrees in orientation was sufficient to cause signals to drop from R9 to 0 intensity at a point approximately 100 miles away. Much trouble was also encountered with "squealing" superregenerative receivers. We remarked on this page once before that two-tube "self supering" receivers produced QRM of highly undesirable proportions and that even though we manufactured them we did not recommend them for other than strictly portable field work.

As we have also remarked before, proper insulation is extremely important on 56 MC. Numerous proofs of this were noted during the test. For example, a 2B7 used as oscillator and first detector refused to oscillate at 56MC until the base was slotted to reduce losses. We finally ended up by rebasing the tube. Other examples could be cited, but they all proved the same point, that the insulation must be low-loss in every part of the high frequency circuit.

Although the losses in dielectrics can be measured roughly without elaborate equipment, most amateurs probably do not wish to spend the time and effort required to obtain numerical results. However, price happens to be a good indicator of quality, for we have found that among leading dielectric manufacturers you get just about what you pay for.

JAMES MILLEN



Gang-Way!

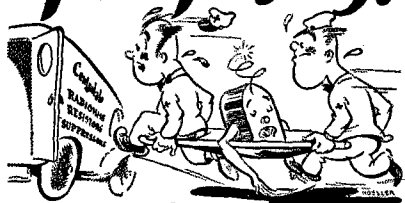

here's Real relief for run-down Radios!



The new patented RADIOHM

When the frantic parents of a once-healthy radio call on you to revive their loved one . . . see that your stock of life-giving CENTRALAB replacement parts is in order.



The sturdy fixed RESISTOR

For D. R.'s* all over the country are doing heroic work with Centralab Radiohms, Resistors and Suppressors.

Experimenters too are using Centralab parts for better results.

*D. R. — Doctor of Radio.



The efficient MOTOR RADIO SUPPRESSOR

Every Radio Service Man should be a member of the Institute of Radio Service Men

Centralab

Central Radio Laboratories

MILWAUKEE

ding. Let the lids use 3.5 or 1.7 mc. Let them use 14 mc. and higher frequencies if they can make a transmitter work there.

Can't the League work with the Federal Communications Commission to get something done? Missouri is for it. . . .

—R. Wade Caywood, W9KGX

Editor's Note.—The petition bears 34 names. Another similar petition is said to be in existence, but has not been received at A.R.R.L. headquarters.

Listen, Brasspounders!

R. F. D. No. 1, Edmonds, Wash.

Editor, QST:

Whenever you hear "CQ-CQ-CQ Up She Pops," it will pay you to get QSO with W7UE. That call means that the OM is on an even hundredth QSO and the lucky one who gets QSO with him will receive one of his net twine belts. The only condition is that the QSL card of the party worked must be in his shack inside of thirty days. If you have worked him before with the same call and have QSLed, then no further card is necessary on this "Up She Pops." W7UE started this stunt last fall, so if you get QSO with W7ASF, W7DJJ, VE5IC, W7CDA, W7DYJ, W9OAK, W7DYD, W7BTZ or W7RL, just ask them about the belt. A W6 and W5 failed to qualify.

The belt is made with No. 9 fisherman's net twine and has over 3000 square knots, and takes from ten to twelve hours to make.

W7UE learned to make these belts when he sailed to Borneo in 1927. This operator is over sixty years young and still very active in the game after ten years of hamming.

W7UE works on 20, 40 and 80, so watch your step, gang.

—Samuel S. Atwood, W7UE

CQ DX

1991 Carlton Ave., Niagara Falls, Ontario, Canada

Editor, QST:

I read in the report of results in the last International DX Contest that, in future contests, you are considering making it taboo for W/VE stations to call "CQ DX." I have also seen this system derided before in the pages of QST.

Why are you so against this? After all, what is poison in one case may be duck soup in another, and the method that produces the best results for John Q. Ham is obviously the method for him to use.

My transmitter, having less than 100 watts input, may be said to be in the low-powered class, and my own experience has shown that the low-powered ham has a much greater chance of contacting foreign DX by calling "CQ DX" than by calling an individual station. Just go over the 7-mc. band any morning when conditions are good and count the number of W's calling, for instance, VK5HG. This a.m. I counted fourteen W's going after VK4EI, so that if I had also called him, my chance of raising him would have been one in fifteen, not considering the others who called him that I couldn't hear. Consider also that probably one third of the stations that I actually did hear calling would have much more power than I have, and my chance would have been even smaller.

Now, I believe that there are just as many VK's, in proportion, who listen for DX signals, rather than call CQ, so that if I call "CQ VK" or just plain "CQ DX", my chance of hooking a VK is, say, 15 to 1, and not one in fifteen as before, provided—there is always an "if"—that my signals are getting down there. Of course, it is understood that my rig must be capable of pushing its sigs into distant points. Several factors enter into this, chief of which is my sky-wire and the least important, my power input.

That is my system for working DX—I call "CQ DX" and it works! Sometimes I call certain stations when I know there must be others also calling, and sometimes I hook them. But 90% of my foreign contacts are made by letting the other fellow call me. So why rule that I cannot enter a contest unless I do the calling when the other system works best for me? That is obviously unfair.

. . . So let's have another DX contest soon, but forget about the fellows who are pounding out "CQ DX"! Perhaps they are getting results.

—H. Jolkoff, VE5IG

AN EXCELLENT STANDBY RECEIVER FOR AMATEUR PHONE — A REMARKABLE SET FOR ALL SERVICES

20-meter Phone . . .
80-meter Phone . . .
175-meter Phone . . .

And practically everything
each side and in between

The dial on the new General Electric All-wave Radio tells the whole story. It is divided into four frequency bands covering 140-410 kilocycles, 540-1720 kilocycles, 1720-5400 kilocycles and 5400-18,000 kilocycles. Practically every service the amateur is interested in is included, with the range conveniently divided into these four bands.

Never any question as to which band is in use — a visual band indicator tells you.

AND BAND-SPREAD TUNING

Fine tuning with double-end needle and fully illuminated dial, giving excellent visibility. Two tuning ratios, 50 to 1 and 10 to-1, either one instantly available. In addition, band-spread tuning is accomplished by an additional needle with separate scale. The band-spread needle is geared to the main needle, giving minute logging of the fine tuning obtained with the 50 to 1 tuning ratio. Nine revolutions of band-spread needle to cover each frequency band. Thus, you locate desired frequencies more easily and rapidly. What's more, you can log short-wave stations accurately, and return to the desired frequency conveniently and quickly.

AND C. W.

This set can be adapted for C. W. reception without cutting a wire. Write for complete instructions on this adaptation.

AND LESS NOISE

The set is adapted for the use of double-doublet all-wave antenna, provision being made in the receiver for easy attachment.

AND TONE AND WALLOP

High-gain, 6-watt audio system feeding a large built-in dynamic speaker. Plenty of volume for weak signals, and, at the same time, excellent fidelity for broadcast reception.

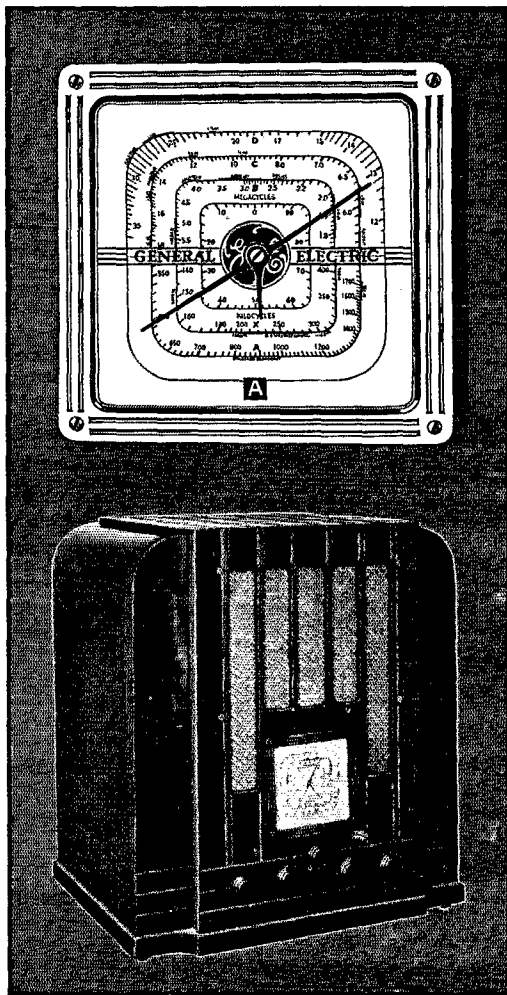

GENERAL ELECTRIC ALL-WAVE RECEIVER
MODEL M-81

PRICE \$97.50 COMPLETE

In addition, a full line of all-wave models from \$39.95 to \$375.00. (Prices slightly higher West, Mid-West, and South.) Subject to change without notice.

GENERAL ELECTRIC

ALL-WAVE RADIO

MERCHANDISE DEPARTMENT, GENERAL ELECTRIC COMPANY, BRIDGEPORT, CONN.

Once You Get the Habit Everything Will Be PLUG-IN

VARIOUSLY spelled "plug-in," "plugin," or just plain "plug in," the result is just the same. For use in transmitters, receivers, monitors, oscillators, 5-meter gear, and now 112-mc and 224-mc equipment, the original G-R plugs and jacks are the solution to all interchangeable problems. And the newer Jumbo heavy duty sizes for once and for all settle the question of how to make copper tubing inductances.



274-P

TYPE 274-P PLUG TYPE 274-J JACK

Hundreds of thousands of these have been sold since their introduction several years ago. For receivers, oscillators and the low power stages of multi-stage transmitters — improved design — excellent contact — mechanical rigidity.



274-J

Type 274-P Single Plug (6-32 shank), 6 cents

Type 274-J Jack, 5 cents

TYPE 674-C (Jumbo Size) PLUG

TYPE 674-J (Jumbo Size) JACK

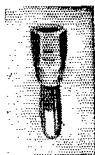

674-C

The Type 674-C plug has a hexagonal shank, thoroughly tinned inside and partially filled with solder so that copper tubing may be sweated in. High current capacity — enough for any amateur transmitter.

Type 674-C Single Plug (hollow shank), 20 cents

Type 674-J Jack, 25 cents



674-J

Other plug-jack combinations described in our Amateur Bulletin 934-Q10, a copy of which is available for the asking.

Order direct from this advertisement. Sent prepaid anywhere in the U. S. and Canada if cash accompanies order.

General Radio Company

30 State Street

Cambridge A, Mass.

Detroit Police Coöperate With Amateurs

(Continued from page 17)

earing work at WCK and WPDX (2414 kc.) brought about the development of police radio to the state which has to-day caused the adoption of its system in practically every major city of the country. Entirely in line with its forward-looking policies, Commissioner Pickert has approved a plan of coöperation between the Department and Detroit radio amateurs.

Detroit amateurs desiring to obtain the information of local or national disasters and emergencies will be listed with their telephone number, call, name and address with the number of the scout car covering territory in which the amateur station is located. These amateurs will be expected to keep a station ready for operation at all times. Also they must be willing to be awakened at any hour of the day or night. Whether the awakened amateur goes back to bed or not is his own business—but picture, if you can, a ham missing a chance to get in on some important QRR work!

We do not expect any emergencies of the sort referred to to occur in Detroit itself, but we know that we can be of the greatest assistance by relaying between points that cannot communicate because of skip-distance effect, disrupted wire service, etc., and we will be prepared for the worst. Also we can clear the air of QRM, if nothing else. Affiliation with the Michigan State Police and local sheriff's offices is being sought. (WRDS 1574 kc.)

A list of "enlisted" amateur stations will be kept at the radio stations and will be in the hands of such well-known amateurs as ex-8KJ, W8HP, ex-8DQC, ex-8ASM, ex-9AIX, W8ARR, W8DUR, W8BJ, W8IPO, Handley of 9ZN, ex-W8FWU and W8DYH, operators of WCK-WPDX.

Thanks are hereby given to Sergeant E. C. Denstaedt, Supervisor of Radio, Detroit Police Department, and Mr. Frank Pipp, W8BJ for the kind assistance in arranging this coöperation.

What the League is Doing

(Continued from page 20)

not been able to cast a vote, and has had to confine his activities at the meeting to discussions and observation. But an alternate director, duly elected to that position by the membership, *does* have the right to vote at a meeting when he attends instead of the director; it was to insure this that the office was created.

The second new feature this year is that only members of the League who are licensed amateurs (or members who have maintained continuous membership since May 15th of this year) can vote—no other votes will be counted. Voting has been about 80% "licensed" for many years, but from now on it will be virtually 100% the action of licensed amateurs only.

**YOU CAN LIVE IN
THE SHADOW OF A
VOLCANO
...but for how long?**

THE volcano may slumber on for months, years, but when it does erupt—heaven help those who have stayed living in its shadow!

All of which might be likened to the false sense of security enjoyed by those who have "successfully" employed cheap, inferior condensers.

Don't trust to luck. Put your trust in **CARDWELLS!** Time after time they've proven their worth through every gruelling test. That's why those who *KNOW* insist on **CARDWELLS.**

Send for literature

★ ★ **NOTICE:** *Increased manufacturing and material costs have made unavoidable increases in the list prices of MIDWAY and TRIM-AIR condensers. Therefore, effective Oct. 1, 1934 the list prices of MIDWAY and TRIM-AIR condensers will be advanced 10% over present list prices. This is the first increase in list prices ever made by Cardwell—reductions have been the rule—and other models remain, at sacrifice to us, at the reduced list prices of two years or more ago.* ★ ★

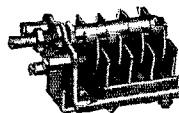

NEWS! *Type 519-8 for neutralizing 830 tubes. A compact condenser with extra wide spacing. Designed for panel or shelf mounting. Provided with positive, non mutilating rotor lock.*



CARDWELL "STANDARD" MODELS
FOR RECEIVERS
and MEDIUM POWER TRANSMITTERS

CARDWELL MIDWAY "FEATHERWEIGHT"
CONDENSERS, RECEIVING & TRANSMITTING

CARDWELL 16-8 TRANSMITTING CONDENSERS
FOR LARGER TRANSMITTERS

CARDWELL HIGH VOLTAGE CONDENSERS
FOR COMMERCIAL RADIO-TELEGRAPH
and BROADCASTING STATIONS

CARDWELL S-2244 OIL DIELECTRIC
FIXED CONDENSERS FOR HIGH FREQUENCY
FURNACES and TUBE BOMBARDERS



THE ALLEN D. CARDWELL MFG. CORP'N.

83 PROSPECT STREET, BROOKLYN, N. Y.

"THE STANDARD of COMPARISON"

Say You Saw It in *QST* — It Identifies You and Helps *QST*

THE IMPROVED CATHODE-RAY OSCILLOSCOPE

Linear sweep model for broadcast stations and advanced amateurs, physics labs., etc.

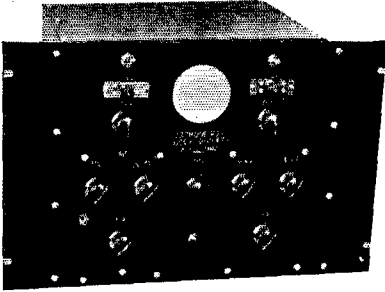

● Controlled linear sweep 0-150,000 C.P.S. ● Controlled external sweep. ● Freq. locking device for sweep frequency. ● Picture centering adjustments. ● Wide range focus adjustments. ● Complete component shielding. ● Unit is self contained and includes batteries and 110V-60 cycle power supply. ● Tubes RCA 906-885-234-281-280. ● This instrument embodies all features ordinarily contained in only the highest priced Cathode Ray equipment.

COMPLETELY EQUIPPED READY TO USE

F.O.B. Newark — \$97.50

Literature now available

Thordarson Specials

FILTER CHOKE \$2.75
250ma — 12h — 110 ohms

POWER TRANSFORMER \$3.35
600-600-200ma
2½ V. @ 10A; 5 V. @ 3A; 7½ V. @ 4A.
A Real Husky Transformer

TUBES

210

15W

Large
Plate

\$1.15

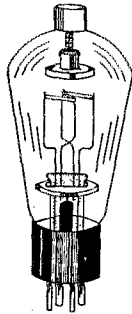

866

1000 hr.
Guarantee

New
Construction

\$1.35

Subject to Prior Sale.

8-RCA 852 — \$17.50 ea. — 17-RCA 204A — \$30 ea.
These tubes are like new, none having been used more than 2 hours.

866 Filament Transformer. Steel case with porcelain terminal bushings. \$2.85

Dubilier sulphur type R.F. by-pass condensers. 1000-V working voltage. .0025 — perfect for plate blocking on 50-watt tubes. Usually sold for \$2.50. 65c

Duplex power supply. 1100V — 250ma 550V — 250ma. \$35

We are specializing in transmitter construction to customers' orders and specification. Write for quotation on your favorite transmitter.

Special code classes for beginners. No charge. Telephone for appointment.

KALTMAN & ROMANDER
62 Court St. Newark, N. J.

Foreign Traffic We are now permitted to handle third-party traffic internationally with Chile, under the same general terms applying to the several other countries with whom similar agreements have already been effected (see September *QST*, page 30). At the initiative of the League our State Department finally negotiated the Chilean agreement on August 17, 1934.

Directors Our editorial this month intentionally directs attention to the activities of League directors at the annual May board meeting, but this should by no means be interpreted to imply that they exercise their directorial powers at only this one time each year. Directors are active in League affairs every day of the twelve months. Through attendance at conventions and hamfests, and by means of correspondence they make every effort to be thoroughly familiar with what is going on in their divisions. If municipal or state legislative threats show up in their territory, they track it down, advise headquarters and frequently devote days of effort in cooperating with the officers and the League's general counsel to bring about the defeat or modification of some obnoxious measure. They are in receipt of a steady stream of special bulletins, memoranda and executive committee minutes from headquarters, to keep them constantly advised of what the League is doing, and what is happening of interest or importance to amateur radio here and abroad. Their correspondence with headquarters frequently attains voluminous proportions.

It is a mistaken assumption to regard the director as one who exists only to attend a board meeting for two days each year. His is a 365-day job—and a hard one.

High-Power 'Phone DeLuxe

(Continued from page 86)

to visit it, unfortunately. This receiving system is designed and built so that the effects of fading are very nearly overcome, and the customers get practically constant signal strength.

It was mighty stimulating to see a regular station where things were engineered with unusual thoroughness, and where financial corners did not have to be cut too closely—in marked contrast to most ham stations, alas! But we hams have the fun and thrills of DX, skeds, and ragchews, and we can change set-ups at will—with the whole world (including QRM) in our receivers. So envy not those ops restricted to point-to-point-via-beam transmission!

Strays

One response to the "big antenna" stray in July *QST*: Don Wallace, W6AM, had one 612 feet long up till about six months ago, when the antenna was changed to two 405-foot wires in a directional "V," making a total of 810 feet.

Ten Years Ago . . .

passing the government amateur operator license examination was little more than a formality. Ten rather simple stock questions were asked, and the questions were always the same. You passed your code test — or, more often, swore that you could if called on to prove it — and that was that.

To-day . . .

things are mighty different. When you step up for that examination (and you *have* to step up; there's no getting out of it, unless you're in the remote wide stretches and even then the exam is just as hard) you may be asked any ten of a group of hundreds of questions — all different, and all difficult. You have to know your stuff to get an amateur license these days. Requirements have been stiffened; the art has broadened, branched out, increased in complexity. Amateur radio of today is a far more complicated and involved affair than it was ten years ago; you have to be able to keep up, if you expect to join the race.

Now . . .

There's only one sure way to guarantee yourself that 1934 speed. There's only one sure way to insure yourself the knowledge, the ability, the technique required to pass that stringent present-day license examination. That sure way is to use the A.R.R.L.'s complete Course of Study for the Would-Be-Amateur:

HOW TO BECOME A RADIO AMATEUR

(No. 8 in the series entitled The Radio Amateur's Library)

A necessity for the fellow who wishes to get started right.

25c postpaid

THE RADIO AMATEUR'S LICENSE MANUAL

(No. 9 in the series entitled The Radio Amateur's Library)

Complete dope on license procedure, with questions and answers.

25c postpaid

(No stamps, please)

THE AMERICAN RADIO RELAY LEAGUE
WEST HARTFORD CONNECTICUT

THE SNAPPER

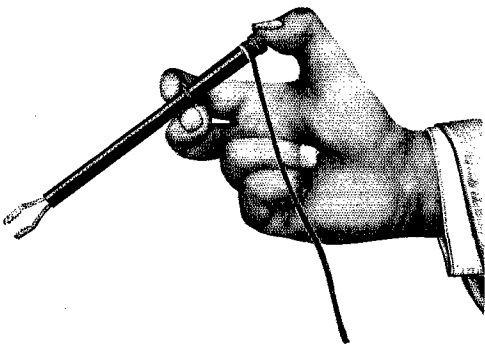

A New "Triple Threat" Radio Tool

THE long tube is of insulating material and is fitted with spring contact jaws on the far end. The jaws are operated by a push of the thumb on the near end.

Cord is connected under insulated knob binding post as illustrated.

IT MAY BE USED AS

1. A "Deep Sea" Electric Test Clip — Test contacts may be made with ease, deep in the recesses of a radio chassis with **no danger of short circuits**. You can reach spots you never thought of reaching before without tearing down the whole chassis.
2. An Electric Contact Prod — The clip jaws may be used to make quick prod contacts. Or better still — clip one Snapper on the ground circuit and prod with another.
3. A Retriever — Use the Snapper to pick up small screws and nuts or other odds and ends that may accidentally be dropped into inaccessible places.

Mueller Electric Co.

1584 East 31st St. Cleveland, Ohio

Makers of Mueller Universal Clips

SEND \$1.00

FOR TWO SNAPPERS POSTPAID
(List 75c Each)

(Packed 2 in a box — 1 red and 1 black)

Clip the Coupon

Mueller Electric Co.
1584 E. 31st St., Cleveland, Ohio

Gentlemen:

I enclose \$..... for which please send me postpaid Snappers at 50c each net.

Name.....

Address.....

.....

Practical Communication on the 224-Mc. Band

(Continued from page 11)

is very important, with this type of condenser, to insulate the rotor from ground. The inductance, supported between the two lugs of the tuning condenser, consists of five turns of No. 18 wire, wound on an ordinary round pencil (about 5/16" diameter), the turns being spaced approximately the diameter of the wire. The tap is located on the third turn from the plate end of the coil.

The remaining features of the receiver are perfectly conventional and can be followed from the circuit and photographs. It might be mentioned that the channel on which the receiver is assembled measures 7½ inches by 3¼ inches by 2 inches deep. A Lecher system again could be used to check the frequency of the receiver and the check might well be followed by listening to the harmonic produced by small 5-meter transmitter or a 5-meter receiver oscillating but not super-regenerating. The harmonics so obtained will, of course, appear as dead spots in the 224-mc. receiver and in our case they were very well defined and permitted a splendid check of the calibration obtained with the Lecher system.

If a Lecher system has not been used to check the frequency of the receiver (or if the receiver has not been checked against a "Lecher-checked" transmitter) there is some danger of mistaking the third harmonic from a 56-mc. oscillator for the fourth. Any possible doubt can be cleared up by setting the "five-meter" oscillator on 60 mc., then finding what appears to be its fourth harmonic on the new receiver. If it really is the fourth harmonic, another harmonic (the fifth) will be obtained by tuning the "five-meter" oscillator to 48 mc. Since a suitable frequency meter may not be available for this test, we suggest dependence on the Lecher method.

The general procedure in tuning the transmitting antenna and in coupling the receiver to its antenna follow exactly along the lines observed in 56-mc. working.

The purpose of presenting this sketchy description of a transmitter and receiver for the new band is to provide some basis on which to start actual communication. Several stations in the New England area are all set to make new records on 224 mc. and we anticipate that activity on this band will soon be giving 56 mc. a tough run.

Plunk down your vest-pocket directive antennas, gang, and let's find out just how much fun we have been missing—it's plenty.

Strays

Poor quality from a velocity mike may be the result of using a mounting designed to "look pretty." These mikes should not be enclosed nor baffled under any circumstances, since the faithfulness of the response depends upon the free-

A. C. RELAYS

Made by

Allen-Bradley

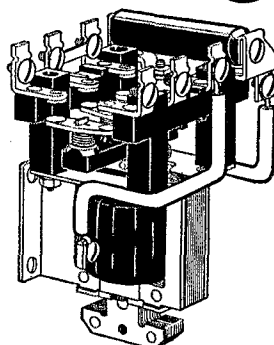
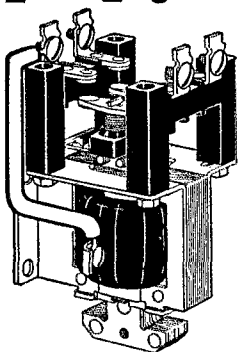

These A. C. solenoid relays are ideal for remote control of transmitters, for control of crystal ovens, and for any general remote control application except for keying. THESE RELAYS WILL NOT OPERATE IN KEYING SERVICE. Silver-to-silver double break contacts are used throughout.

The maximum contact rating is 10 amperes at 220 volts. The relay coils are wound for 115 volts 60 cycle alternating current. Relays for other voltages can be supplied on special order. Use coupon below when ordering.

Type No.	Poles	Nor- mally	Circuit Diagram	Price		Type No.	Poles	Nor- mally	Circuit Diagram	Price	
				Open	In Cab.					Open	In Cab.
A107	1	Open		\$3.50	\$4.50	A177	1	Closed		\$7.50	\$8.50
A117	1	Closed		4.50	5.50	A207	2	Open		4.00	5.00
A127	1	Open and Closed		5.00	6.00	A217	2	Closed		6.00	7.00
A137	1	Open		4.00	5.00	A227	2	Open and Closed		7.00	8.00
A147	1	Closed		5.00	6.00	A237	2	Open		4.50	5.50
A157	1	Open and Closed		5.50	6.50	A247	2	Closed		6.50	7.50
A167	1	Open		6.50	7.50	<p>Radiostat—A stepless graphite compression rheostat for primary of 550 watt filament or plate supply transformer. Range 4 to 150 ohms. Price \$6.50</p>					

ORDER BLANK—MAIL WITH REMITTANCE TO

Allen-Bradley Co., 108 W. Greenfield Ave., Milwaukee, Wis.

Enclosed find money order for \$.....for which please send me, shipping charges prepaid, the following items:

Name.....

Address.....



AMATEUR TUBES

DESIGNED TO DELIVER HIGH OUTPUT WITH HIGH EFFICIENCY IN AMATEUR EQUIPMENT

RK-20 RF PENTODE

50 Watts R.F. Output as oscillator or amplifier. Suppressor grid modulation with one watt R.F. excitation and .2 watt audio power. No neutralization.

Amateur Net Price \$15.00

RK-18 TRIODE

40 Watts Output as oscillator or amplifier. High μ , high mutual conductance with low plate resistance. Highly efficient. Low internal capacitances for 60 megacycle operation. Class B output per tube — 50 watts.

Amateur Net Price \$10.95

ALSO

- RK-15. 2.5 V. Filament
400 V. Plate HiMu Triode \$5.00
- RK-16. 2.5 V. Heater Type
400 V. Plate Triode \$5.00
- RK-17. 2.5 V. Heater Type
Pentode for the TriTet \$5.00
- RK-19. 7.5 V. Full Wave High Vacuum
Rectifier for the 1000 V. Power Supply . . \$7.50
- RK-24. 2.0 Volt 0.12 Ampere Special
Triode for 60 Megacycles \$2.25
- R-866A. Half Wave, Internally Shielded
Mercury Vapor Rectifier \$5.00

See your dealer or write to the address near you.

RAYTHEON PRODUCTION CORPORATION

30 East 42nd Street, New York, N. Y.

or

San Francisco — Chicago — Newton, Mass.

dom with which sound waves can pass through the device. Even a sheet of paper held behind the microphone will cause a marked decrease in fidelity. A wire mesh or screen housing is OK, however.

The velocity microphone operates to best advantage when held about eighteen inches from the mouth and when the operator is speaking in an ordinary tone of voice. If the mike is close to the mouth, lip noises become too prominent.

—W3ADI

The receiving station of S.H.J.V. Ewijk-N. Amstellaan 908, Amsterdam-Z, Holland, has been compiling reports on DX sigs since 1928 and will gladly listen for any station on any frequency upon request. This receiving station is operated in the interest of international friendship and goodwill.

The new "postcard" licenses are convenient for carrying around but, says W6HJL, they're likely to be in pretty poor shape after three years in a ham's pocket without protection. He suggests cutting two pieces of celluloid the size of the license and binding the card between them with art binding or similar adhesive tape. This will keep the license clean and prevent tearing.

In connection with W9IWW's suggestion for simultaneous use of a twisted-pair feeder antenna for transmission and reception, given in the Experimenters' Section in July *QST*, W3EQP writes that he has been using a scheme similar in principle but slightly different in the details. W3EQP simply winds two or three feet of small wire in the groove between the two strands of the pair to give the necessary capacity coupling. Since the third wire is equidistant from the other two, the capacity balance of the system is not disturbed.

Not So Hot!

We uttered a groan recently when W3AQR advised that the low-power 5-meter enthusiasts in his locality test the transmitting equipment for oscillation by touching the plate coil with the tongue! Apparently the younger generation can "take it."

Be Careful!

From time to time complaints reach us of magazine subscription solicitors who offer *QST* in combination with other magazines. Such combination is generally offered at a reduced rate. Let it be known here that *QST* is never authorized to be offered in combination with other publications. Any solicitor offering *QST* in combination or at a reduced price should be refused, and we would appreciate it if the matter is reported to us with the name and description of the solicitor. We immediately investigate such matters and report them to The National Publishers Association, 232 Madison Ave., New York City,

NEW YAXLEY

TAP SWITCHES CIRCUIT SELECTOR SWITCHES SHORT WAVE SWITCHES

*are unequalled in Quality,
Flexibility, and Performance*

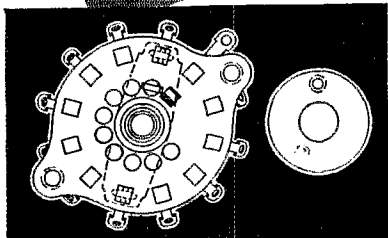

Showing adjustable stop arrangement on locating plate.

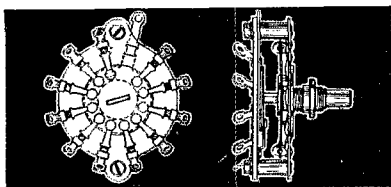

Single gang switch showing contact and circuit arrangement.

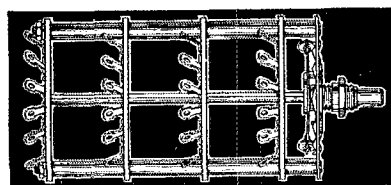

Four gang switch giving assembly.

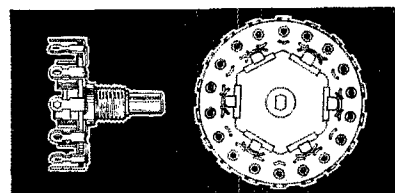

2700 type switches showing assembly and contact arrangement.

- The new adjustable stop feature provides many additional combinations in each switch and makes it possible to use a single switch for many different specifications. Switches may be wired in circuit experimentally, then adjust the stop for permanent installation.

New Yaxley 1200 and 1300 Type Switches

The new design used in the Yaxley 1200 and 1300 type Switches is identically the same construction as are used and specified by the largest percentage of manufacturers making all wave receivers. Set designers demand the lowest contact resistance and capacity between circuits, which requirements are supplied in this type of Yaxley Switch.

All contacting members of the Yaxley Circuit Selector Switches are silver plated with a hard finish which will withstand the wear throughout the life of the apparatus in which the switch is used.

The unique design of the 1200 and 1300 type switches provides circuit combinations on each section which answers practically every requirement. They supply these circuits in a minimum amount of space.

The special Bakelite Insulation in these Switches is of the best quality obtainable for Switch purposes. It has the lowest moisture absorption of any Bakelite available.

New Yaxley 2700 Type Switches

The new Yaxley 2700 type Switches are supplied only in single gang and in two sizes—one 1½" in diameter and the other 2" in diameter. These are designed for the simpler circuit functions.

The 2742—with the 1½" base can be used in combinations from single pole, single throw to four pole, double throw.

The 2762—with the 2" base includes all of the above combinations and provides from a five pole, single throw to six pole, double throw in addition.

Completely listed and illustrated in Yaxley Catalog Y-203. Write today for your free copy!



YAXLEY MANUFACTURING CO.
INCORPORATED
Division of P. R. Mallory & Co., Inc.
INDIANAPOLIS · · · INDIANA
Cable Address Pelmallo



TODAY'S

Most Modern

Precision Measuring Instruments

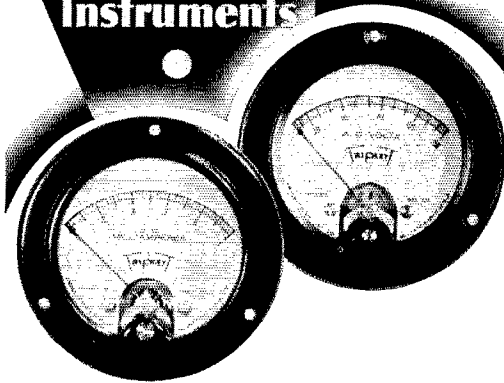

WHEN selecting your instruments for use in radio circuits you eliminate all guess work when you specify Triplett. There is a Triplett instrument for every radio application, designed for your particular needs. Your transmitter circuits should have Triplett instruments for best operating results, appearance and all-around efficiency.

D. C. Triplett instruments are of the moving coil type; A. C. Triplett instruments are of the repulsion iron type. Expertly designed. Craftsmanship unsurpassed. Bakelite and metal cases—2", 3", 5" round panel styles. Also rectangular square and fan styles. Portable 3" have tilting scales; 5" have mirror scales.

Ultra sensitive instruments for special and standard applications; relays for low current operation; thermocouple for high frequency; rectifier type for sensitive A. C. measurements. Every modern application where good instruments are required.

Consult your jobber for all standard instruments. Send your inquiries to

**THE TRIPLETT
ELECTRICAL INSTRUMENT COMPANY**
98 Main Street, Bluffton, Ohio



Triplett Electrical Instrument Company
98 Main Street, Bluffton, Ohio

Gentlemen: Please send your latest literature on Triplett Instruments.

Name.....

Address.....

City..... State.....

where all such operations are nationally publicized to stop such unauthorized actions.

DX Transfers

MacCutcheon of NY1AB has left, and Vandekamp of the same station, 7-mc., and the recent DX contest fame, is carrying on. OM2LD, L. A. Langford, has been transferred to Radio Central, Navy Department, Washington, D. C. Lieut. D. C. Redgrave of KA1NA has been transferred to the Secretary of the Navy's office in Washington. Bob Adams, former president of the Atlantic Division Radiophone Association, is now at NY1AA; to date there is no voice modulation.

Silent Keys

It is with deep regret that we record the passing of these amateurs:

- S. R. W. Edwards, VK3RQ, East Preston, Vic., Australia.
- Harry C. Hayes, W2DEP, Belleville, N. J.
- Wm. Walter Leab, W4BZS, Jonesboro, Tenn.
- Harvey T. Robinson, VE3AE, Clinton, Ont.
- Carl Ruecker, W6JYK, Santa Ana, Calif.
- F. H. Sanger, W8LRF, Rochester, N. Y.
- Vernon Sorrels, W9SLX, East St. Louis, Ill.

Carrier Ratings With S.G. Modulation

(Continued from page 37)

mitter is rated at a maximum of 100 watts for c.w., that 100 watts becomes the *peak* rating for 'phone. Since the instantaneous modulation peaks reach a maximum of four times the carrier power at 100% modulation, the correct 'phone carrier rating for the transmitter becomes one-fourth of the peak, or 25 watts.

Only in plate-modulated 'phone systems—where the modulator has some real power output and therefore costs real money—are the 'phone and c.w. carriers equal. Suppressor-grid modulation doesn't offer something for nothing. It is a nice way of getting 100% modulation with small distortion and inexpensive modulating equipment. But the 'phone carrier output for complete modulation can be only one-fourth the c.w. capabilities of the tube.

Incidentally, the manufacturer's output rating on the RK-20 as a power amplifier is 50 watts. This means that a suppressor-grid-modulated 'phone using one RK-20 should be rated at 12.5 watts, or using two RK-20's should be rated at 25 watts. Slightly higher power can be obtained by increasing the plate voltage above the recommended 1000 volts, but the above ratings are the only fair ones for commercial purposes.

The

BIG NEWS IN AMATEUR RADIO

The 1935 TWELFTH EDITION of the

Radio Amateur's Handbook

IS READY!

The whole book has been brought right up to date. The chapters on transmitters, receivers and phone have been completely rewritten describing the latest developments in new equipment. The ultra-short-wave chapter has been greatly expanded to cover completely the recent work with directive antennas on five meters and $1\frac{1}{4}$ meters—the most important and interesting new field for amateur work.

\$1.00

POSTPAID ANYWHERE

THE AMERICAN RADIO RELAY LEAGUE

WEST HARTFORD

CONNECTICUT

For Your Convenience . . .

The R-S-T system, given publicity by A.R.R.L. in October *QST*, seems to be rapidly coming into universal use. The system has received acclaim from many sources. The simplicity, lack of confusion in definitions, and the completeness and brevity of the R-S-T plan of exchanging reports has a strong appeal to all operators who value these qualities. For your convenience we are printing a chart showing the new R-S-T signal report system in full below. Cut this out and put it in your operating position:

R-S-T

Readability

1. Unreadable
2. Barely readable—occasional words distinguishable
3. Readable with considerable difficulty
4. Readable with practically no difficulty
5. Perfectly readable

Signal Strength

1. Faint—signals barely perceptible
2. Weak signals
3. Fairly good signals
4. Good signals
5. Very strong signals

Tone

1. Extremely rough, hissing note
2. Very rough a.c. note—no trace of musicality
3. Rough, low-pitched a.c. note—slightly musical
4. Rather rough a.c. note—moderately musical
5. Musically modulated note
6. Modulated note—slight trace of whistle
7. Near d.c. note—smooth ripple
8. Good d.c. note—just trace of ripple
9. Purest d.c. note

If the note appears to be crystal-controlled, simply add an X after the appropriate number.

Furnished All Amateurs by The American Radio Relay League

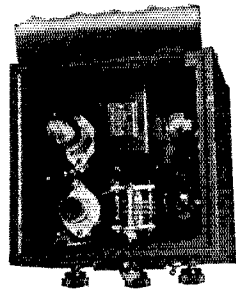

SRR 56 MC RECEIVER

A Non-Radiating Superheterodyne Receiver ideally suited to 56 M.C. Beam Communication.

NATIONAL COMPANY, INC.
MALDEN, MASS.



THIS IS THE ELEVENTH
ISSUE OF *QST* OF 1934

ARE YOUR OTHER TEN IN A

QST
BINDER

?

\$1.50 EACH POSTPAID

TEN YEARS OLD • MANY • ONE YEAR YOUNG

As specialists in the merchandising of short wave and laboratory apparatus

THANKS FELLOWS

As international distributors of radio equipment

NATIONAL PRODUCTS

The complete line for 1935 was fully described in October *QST*. As a large distributor of National parts and receivers, we are in a position to give you the fastest service, because all National products are regularly carried in stock by us just as soon as they come off the production line.

LEEDS TUBES



are going out in fine style and what pleases us most, is, that they are staying out. Type 866 heavy duty rectifier \$1.50 — Type 250 — \$1.20. Type 281 — \$1.10. Type 210 — \$1.15. The type 210-HF is particularly suited for ultra high frequency work, as lava insulation is used internally and a ceramic base eliminates the losses encountered in moulded base tubes, \$1.65. All Leeds tubes carry our regular 30-day guarantee.

moulded base tubes, \$1.65. All Leeds tubes carry our regular 30-day guarantee.

NEON LAMPS

1/4-watt, 1/2-watt and 1-watt. .29c each. For your call letters in Neon 2-watt with standard screw base.49c each

All RAYTHEON transmitting tubes in stock

RK 20 \$15.00

BIRNBACH insulators in stock

SPRAGUE compact paper condensers. .01 mfd, .08 mfd and dual .05 mfd, .025 mfd.10c
 DUBILIER cased condensers. .1 mfd, .25 mfd. 5 mfd. Each.10c

New Junior VIBROPLEX in stock; this new bug key must be seen to be appreciated. Price \$10.00

RCA #955 tubes in stock \$3.75
 955 Mycalex sockets, special.60
 Western Electric type P-11 phones.3.95
 Leeds C.P.O. code practice oscillator.1.75

Navy Type Telegraph Key

List \$3.60. Navy knob—1/2" Tungsten contacts. Only a few left at \$1.15
 With regular knob95
 Leeds transmitting key, spec.65

Our 12-page folder B-73 describes our complete line of equipment for amateur use. Racks, panels, bases, demi bases, modulators, frequency measuring equipment, UHF transmitter and receiver, modulators, power supplies, retransmission units, amateur and service analyzer equipment and two pages of special items. Five cents in stamps or coin brings B-73 to you by return mail.

GENERAL RADIO

Amateur accessories are always in stock. Here are two handy forms for that multiband xmitter.

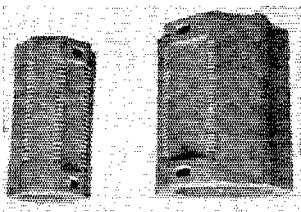

Type 677-U — 21 turns, 2 1/4" diameter, resonant on 3.5 mc with 100 mfd capacity; weight 2 lbs. Price.50c

Type 677-Y — 30 turns 4" diameter, resonant 1.7 mc with 100 mfd capacity. Weight 3 lbs. Price.75c

Also 7-pin base to fit above forms at 70c and a matching base with jacks at 65c.

LEEDS Type 1-F Universal Power Supply



for FB-7 — AGS and receivers with similar power requirements. Both 2.5 v. and 6.3 v. filament supply is available.

Humless of course. Shipping weight 17 lbs. Price. \$9.75

All Star Super-Heterodyne Kit

Complete with oscillator, less antenna. Special. \$32.00

Bulletin on request



LEADS THE FIELD

World Wide Service to Amateurs

45 Vesey Street
 New York City

Cable Address, "RADLEEDS"

ANODYNE

A new name in tubes, with a new number — of intense interest to amateurs. The 859 screen grid transmitting tube graphite anode, ceramic base, 25 watts output at 750 volts plate and last but not least, the lowest price ever for a genuine transmitting tetrode.



\$7

ACME DELTA

We carry the complete line of this quality equipment. Prices are a trifle higher, but all Acme apparatus carries a 5-year guarantee against any type of breakdown.

New Low Prices on WESTON Meters and Service Equipment 25 and 20% discount

GENERAL RADIO Special Split Stator Condensers

Large receiving, spacing; 80 mmi effective capacity \$1.25

Super Special Hardwick-Hindle

200-watt vitrious resistors, 69 ohms, 1000 ohms, 5000 ohms, 6500 ohms; in these sizes only; each. 39c

WARD LEONARD

100-watt vitrious resistors; 400 ohms, 800 ohms, 1000 ohms, 1500 ohms. Each 25c

VULCAN No. 10 Soldering Iron, 44-watt. Special. \$2.45

MAGNET WIRE

All even sizes from No. 14 to No. 38 in enamel, double cotton, or double silk on 25c spools. Prices on larger quantities are yours for the asking.

We know it's going to be a banner year for construction by amateurs because we have been "snowed under" by the response to our offer on manufacturers' bulletins. A "thin dime" to LEEDS brings you post haste 25 nationally known manufacturers' bulletins, our twelve-page B-73 folder and our discount sheet. Don't forget mail-order catalogs do not list the complete line of any manufacturer. Furthermore it costs a quarter to send post-cards to all of these manufacturers to obtain such a large amount of information on the apparatus you are interested in. Just another LEEDS service to enable you to secure the right part for the job.

HUSKY!

JOHNSON TYPE "D"
TRANSMITTING CONDENSERS

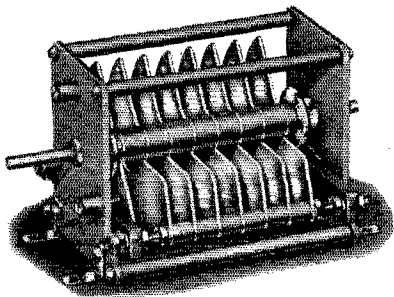

Strong—Rigid—Stable!
High Flashover—High Efficiency!

"Husky" tells the story of the new Johnson Type "D" Transmitting Condensers. They'll stand up under all the punishment you're ever likely to give them, yet they are compact, convenient and inexpensive. See them. . . Compare them. . . You'll want them! There's a full line of Single and Dual-Section Models to choose from.

Get Bulletin 200 from any Authorized Johnson Distributor. It tells WHY Johnson Type "D" Condensers are better!

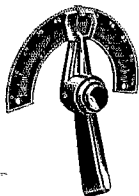

• New •
HANDLE-INDICATORS

You don't need to spend a lot to give your equipment that "commercial" touch! The new Johnson Molded Bakelite Handle-Indicators are rich in appearance, easy to adjust, and permit accurate settings of controls. Two models—furnished complete with etched scale and hardware.

No. 204 — For standard 1/4" shaft. Fits all "D" Condensers. 4" Diameter Etched Scale (zero left).

List Price..... **\$2.25**

No. 206 — Same as No. 204, but for 3/8" shaft and 6" Diameter Scale.

List Price..... **\$3.00**

At Any AUTHORIZED JOHNSON DISTRIBUTOR

E. F. JOHNSON COMPANY

Manufacturers of Radio Transmitting Equipment

WASECA, MINNESOTA, U. S. A.

The Directive Antenna at KAINA

(Continued from page 23)

East Coast stations between 1000 and 1200 GT. The transmitter is remotely controlled, which makes it very inconvenient to switch the antenna for reception.

The results obtained with this system would seem to indicate that time and money spent in improving the antenna is better placed than equivalent effort and expenditure in increasing the power output of the transmitter. An increase in power output from 150 to 600 watts will raise your R6 reports up to R7, but this same 150-watt transmitter used with a directive antenna as described will give you the equivalent of a greater transmitter power increase in a chosen direction and out-perform a simple half-wave Hertz in other directions.

In conclusion, we would like to express appreciation to Don Wallace, W6AM, for information obtained during the construction of the beam antenna, and to Harry Wright, KA1WR, for the method of wave elimination from the transmission line.

Standard Frequency Transmission

Date	Schedule	Frequency	Date	Schedule	Frequency
Nov. 2	BB	W6XK	Dec. 1	BX	W6XK
	A	W9XAN	Dec. 2	C	W6XK
Nov. 3	BX	W6XK	Dec. 7	A	W6XK
Nov. 4	C	W6XK	Dec. 14	B	W9XAN
Nov. 9	A	W6XK		B	W6XK
Nov. 16	B	W9XAN	Dec. 19	C	W9XAN
	B	W6XK	Dec. 21	B	W9XAN
Nov. 21	C	W9XAN		A	W6XK
Nov. 23	B	W9XAN	Dec. 26	BB	W9XAN
Nov. 28	A	W6XK	Dec. 28	BB	W6XK
Nov. 28	BB	W9XAN		A	W9XAN
Nov. 30	BB	W6XK	Dec. 29	BX	W6XK
	A	W9XAN	Dec. 30	C	W6XK

STANDARD FREQUENCY SCHEDULES

Time (p.m.)	Sched. and Freq. (kc.)		Time (p.m.)	Sched. and Freq. (kc.)	
	A	B		BB	C
8:00	3500	7000	4:00	7000	14,000
8:08	3800	7100	4:08	7100	14,100
8:16	3700	7200	4:16	7200	14,200
8:24	3800	7300	4:24	7300	14,300
8:32	3900		4:32		14,400
8:40	4000				

Sched. & Freq. (kc.)
BX

6:00	7000
6:08	7100
6:16	7200
6:24	7300

The time specified in the schedules is local standard time at the transmitting station. W9XAN uses Central Standard Time, and W6XK, Pacific Standard Time.

TRANSMITTING PROCEDURE

The time allotted to each transmission is 3 minutes divided as follows:

2 minutes—QST QST QST de (station call letters).

3 minutes—Characteristic letter of station followed by call letters and statement of frequency. The characteristic letter of W9XAN is "O"; and that of W6XK is "M."

1 minute—Statement of frequency in kilocycles and announcement of next frequency.

2 minutes—Time allowed to change to next frequency.

W9XAN: Elgin Observatory, Elgin National Watch Company, Elgin, Ill., Frank D. Urie in charge.

★ CONTINUOUS BAND-SPREAD ★
ALL-STAR
ALL-WAVE Superheterodyne

FREE
CIRCUIT AND
PARTS LIST

HERE IS A NOVEL IDEA!

You can start for only \$2.50 and buy as you build. When done, you will own a super with these outstanding features—6-Tube Super Circuit, Continuous Band-Spread, 10 to 500 meter (no skip) range, Airplane dial, Tone control, Built-in power supply for AC operation and many others.

Write for our free catalog

★ **CAMERADIO** ★
603 GRANT ST.
PITTSBURGH -- PA.

YOU DEPEND ON A.R.R.L. FOR YOUR AMATEUR RADIO DO YOU SUPPORT THE LEAGUE WITH YOUR MEMBERSHIP?

For More Than Twenty Years

the A.R.R.L. has been the organized body of amateur radio, its representative in this country and abroad, its champion against attack by foreign government and American commercial, its leader in technical progress.

You Owe Your Amateur Radio of Today to A.R.R.L.

HAD IT NOT BEEN FOR THE LEAGUE

- ▶ amateur radio would never have reopened after the World War
- ▶ the swarming influx of broadcasters in 1922 and 1923 would have killed it off by legislation
- ▶ recent international conferences would have virtually wiped amateur radio from the face of the earth.

The A.R.R.L. could not have achieved these successes without the loyal support of the active amateurs of this country — without the presence of their names on its membership rolls.

YOUR name should be there. Without it, we lose your tangible support. Without it, you lessen our ability to act most effectively in the protection of your hobby.

▶ JOIN THE LEAGUE!

AMERICAN RADIO RELAY LEAGUE
West Hartford, Conn., U. S. A.

I hereby apply for membership in the American Radio Relay League, and enclose \$2.50 (\$3.00 outside of the United States and its Possessions, and Canada) in payment of one year's dues, \$1.25 of which is for a subscription to *QST* for the same period. Please begin my subscription with the..... issue. Mail my Certificate of Membership and send *QST* to the following:

Name.....

Street or Box.....

City and State.....

ED WILCOX: W9DDE

now offers

McMurdo-Silver's famous

5C SINGLE SIGNAL SUPER

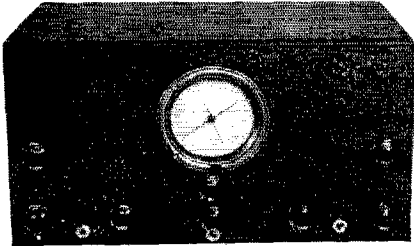

Here's your chance to bring your station up to the minute for the winter's radio activities. The 5C is the improved model of the 5B . . . used exclusively at W9USA at the World's Fair.

Send for free Technical Bulletin

TIME PAYMENTS IN CHICAGO AREA

WILCOX RADIO SALES

506 S. Wabash Ave., WEBster 4101, Chicago, Ill.

LEARN CODE

In HALF
the Usual Time!

It's Easy to do
at Home with

THE NEW MASTER

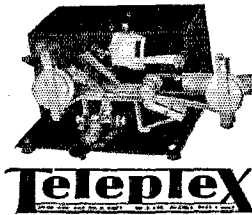

Code Teaching Machine

As a child, you understood spoken English long before you could read or write. You learned by *Hearing*. CODE is the same way! HEAR as you learn, and learn in half the time, with The New Master Teleplex. This world-famous instrument records your sending *visibly*—then *sends back* to you through headphones! The *Natural* method; beginners learn faster, one speed up their wpm amazingly. Used by U. S. Army and Navy, R.C.A., A.T. & T., and others. We give you Complete Course, lend you instrument, instruct you personally—all under MONEY BACK GUARANTEE. Low cost, easy terms. Write now for folder Q23—no obligation.

TELEPLEX COMPANY

76 Cortlandt Street

New York, N. Y.

W6XK: Don Lee Broadcasting System, Los Angeles, Calif., Harold Peery in charge.

WWV 5000-Kc. Transmissions

The 5000-kc. transmissions of the Bureau of Standards' station, WWV, are given every Tuesday continuously from 12:00 noon to 2:00 p.m., and from 10:00 p.m. to midnight, E.S.T. These transmissions are accurate to $\frac{1}{2}$ cycle (one in ten million). —J. J. L.

Book Reviews

Gateway to Radio, by Major Ivan Firth and Gladys Shaw Erskine. Published by the Mac-Cauley Company, New York City. 312 pages, illustrated with 49 halftones. Price, \$2.50.

Amateurs interested in the "behind-the-microphone" section of broadcasting will find this book interesting, if not impressive. The technical man will be disappointed in it, as in nearly every book intended for popular consumption, if he looks only at the chapter devoted to the engineering aspects of radio—that word, in this book, meaning only radio broadcasting. In fact, the presumably most significant point brought out in this chapter is that the radio engineer's life is a dangerous one because he works with very high voltages! The rest of the book, treating of the program side, is better because in writing of the preparation, production, and presentation aspects of broadcasting the writers know whereof they speak. It then becomes adequately what its title implies, and offers a usefully broad and accurate picture of its subject.

Bob's Hill on the Air, by Charles Pierce Burton. Published by Henry Holt & Co., New York. 257 pages. Price, \$1.75.

An orthodox juvenile of the character the younger lads delight in, interesting to hams and their offspring because of the fact that amateur radio occupies a part of the scene.

—C. B. D.

I.A.R.U. News

(Continued from page 41)

call Miss Dunn their friend after the pleasant QSO's she has had with them ZC6FF in Palestine is providing that Asiatic contact for WAC for several East Coast W stations, notably W1WV and W1KH His frequency drifts between 14,285 and 14,290, near d.c. note, and he is on at 1:30 p.m. E.S.T. daily We had a thrill here at I.A.R.U.-A.R.R.L. Hq. the other day when there arrived a phonograph record from the D.A.S.D. Through the offices of W. Slawyk of the Foreign Dept., several officials of the D.A.S.D. addressed greetings to us on the occasion of the Great German Radio Exhibition in Berlin Another interesting experience was the visit of C. R. H. Taylor, ZL2DG, erstwhile editor of "Break-In" and official of the N.Zed.A.R.T., and Mrs. Taylor, in late September They were the second New Zealanders touring the world to stop by this year, Tom Clarkson, ZL1FQ, sometime president of the N.Z.A.R.T., having spent a day at the New England Convention with us last May 5th ON4MY is

Free..

SEND FOR YOUR COPY

RADIO LOG
for
AMATEUR STATION

CALL _____

OP. _____

WESTON
Instruments

—contains useful
circuit information
in addition to tables,
abbreviations, etc.

Send your call card, or
return coupon for your copy
. . . Weston Electrical
Instrument Corporation,
602 Frelinghuysen Ave.,
Newark, New Jersey.



WESTON
*Radio
Instruments*

WESTON ELECTRICAL INSTRUMENT CORPORATION
602 Frelinghuysen Avenue, Newark, N. J.

Gentlemen:

Send me a copy of the new WESTON Radio
Amateur Log.

Name.....

Address.....

Call.....

A MESSAGE

From Operator Henderson, KFS
Who Handles Byrd Expedition Traffic

"For 9 months have been assigned to Byrd Expedition s. w. circuit, working both units — KFZ and WHEW, nightly. Chief Op, Watson, WHEW, Candler trained, is one of the finest ops I ever worked. We hit it up to 45wpm easily. I encounter Candler men in all quarters of the globe. They are fast — plenty! CANDLER COURSE is best investment I ever made. 73."

L. S. HENDERSON, Op, KFS., M.R.T.

CANDLER TRAINED OPERATORS read fast press and commercial stations as easily as they read a newspaper. They copy several words behind with "mill" or pencil, making an accurate "check" as they go.

ANY SKILLED AMATEUR or RADIO OPERATOR will tell you CANDLER Fundamental Training is as necessary to telegraphing as is a knowledge of Ohm's Law to an understanding of electrical phenomena.

FREE — CSCG SCHEDULE, listing all CSCG stations broadcasting Practice Programs from all districts. This is superior practice that costs you nothing. Send for it today. No obligation. Listen to Candler trained operators on your s. w. receiver.

If you want to learn code RIGHT, if you are "stuck," if you want to increase your code SPEED, if you want to learn to use your "mill" in receiving, our BOOK OF FACTS will give you valuable information and we shall gladly give you our advice, based on 23 years' successful training of the World's Fastest Operators. No obligation at all.



Write us today

CANDLER SYSTEM CO.

Dept. G-11—6343 South Kedzie Ave., Chicago, Illinois



WHEN
YOU'RE TUNING
you'll appreciate
OVERLOAD and UNDERLOAD
RELAYS

Send for full information about these two new and useful items. Learn how they are hooked in, how they operate, and the advantage they offer in amateur transmission. Also send for FREE bulletin 507 telling about other handy Ward Leonard Radio Products.

WARD LEONARD ELECTRIC COMPANY

41 South Street, Mount Vernon, N. Y.

Please send information about overload and underload relays. Free bulletin 507.

Name

Street

City and State

Call Signal

particularly partial to W5 and W7 contacts on 14 mc. No reason why some more transatlantic 28-mc. work should not be done when conditions are right, for there are several powerful stations on consistently there now ON4AU, for example, has 350 watts input on that band The 1 kw. power input allowed in Peru has been reduced to 100 watts when the station is within twenty kilometers of the city of Lima

AT-Cut Crystals Available

(Continued from page 18)

Sample AT-cut crystals supplied by the Biley Electric Company of Erie, Pa., have been tried in the QST laboratory and have been found to bear out the advance dope; the crystals stood up well at voltages which would have been certain to crack ordinary X and Y cuts. Nevertheless no crystal is proof against breaking, and the greater power-handling capabilities of the new crystals should not invite abuse. Biley advises that the AT cuts apparently are also less "touchy" about the type of holder used than are the other cuts.

For the time being Biley AT-cut crystals will be supplied for 1.75- and 3.5-mc. only. Since the new cut is only about half as thick as an X cut for the same frequency, the higher-frequency AT-cut crystals are considerably more fragile, physically, than the older cuts, and are therefore more susceptible to damage from mechanical shocks and jars. Crystals which would oscillate satisfactorily have been ground for frequencies as high as 28 mc., however, although their extreme thinness makes their power-handling capabilities small.

Low temperature-coefficient crystals are also being ground by the Bellefonte Radio Engineering Laboratory of Bellefonte, Pa. In the low-frequency range frequency changes of but a few cycles for a 40-degree C. temperature change have been noted.

The Rocky Mountain Division Convention

NOT a soul less than 136 registered at the 8th annual Rocky Mountain Division Convention. According to reports, 136 hams were loud in their praise of the fine time made possible by the Rocky Ford Amateur Radio Association.

After receiving the key to the city from the president of the Chamber of Commerce, the convention group enjoyed talks by John L. Reinartz, Director Andrews and A. A. Hebert.

A highly successful banquet at the exposition building topped off a day chocked with enthusiastic activity. Mr. B. P. Hansen, of the A.A.R.S., Director Andrews, John Reinartz, Ensign Haley, U.S.N.R., and A. A. Hebert provided the speech making. Then, the new movie of the Headquarters staff was shown and an enormous array of prizes distributed. Late at night, the Colorado

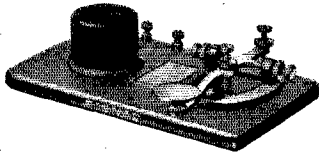

LEARN THE CODE

For those who wish to learn the code this set is recommended. It is well made and low-priced. Send for free circular showing complete line.

SIGNAL ELECTRIC MFG. CO.
Menominee, Michigan

OFFICES IN PRINCIPAL CITIES

SIGNAL
MANUFACTURERS OF ELECTRICAL PRODUCTS

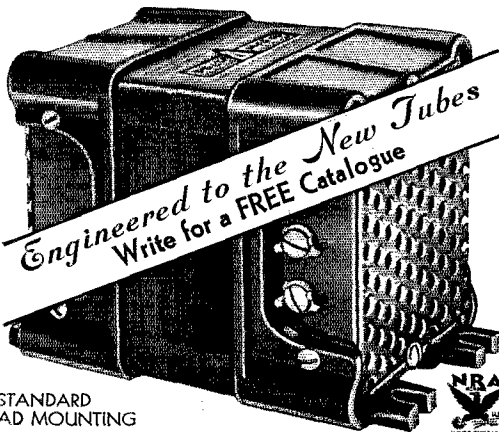

STANDARD
AD MOUNTING

ACME-DELTA

POWER SUPPLY EQUIPMENT

New Acme-Delta Power and Filament Transformers, new Swinging and Smoothing Chokes and the necessary coupling transformers, especially and specifically designed for use with the Raytheon RK-18, the remarkable new RK-20, R. C. A. 800, and the Hygrade-Sylvania 825 and 830-B tubes, are now ready. See the complete catalogue in QST for December, 1933. Extra copies will be gladly sent you on request. Delta Manufacturing Co., 190 Willow St., Waltham, Mass.

F. S. Dellenbaugh, Jr.
Pres. &
Chief Engr.



G. E. M. Bertram
Treas. &
Gen. Mgr.

UNIT OF RAYTHEON MANUFACTURING COMPANY

Spring Club staged an initiation to the Royal Order of the Wouf Hong.

The second day saw more enthusiasm, more talks, more contests and a swell picnic with watermelons and cantaloupes galore. The Greeley Colorado group, who won the privilege of conducting next year's convention, have been given a high standard to shoot at.

New Transmitting By-Pass Condensers

IT HAS become general practice in receiver construction to use by-pass condensers with paper dielectric in circuits where a fairly high (0.002 μ fd. or more) capacity is needed. In the familiar tubular form such condensers offer the advantages of compactness and ease of mounting. Heretofore, however, they have been obtainable only in low voltage ratings and have not been particularly suitable for transmitting purposes. In a new line of this type of condenser, increased voltage ratings have been made possible by the use of oil-impregnated dielectric, so that paper condensers are now available for transmitting circuits.

The new oil-impregnated condensers are intended particularly for use as blocking and by-pass condensers, applications in which a fairly high capacity and ample d.c. rating are required. They may also be used for other purposes, such as antenna coupling condensers where it is necessary to insulate the d.c. plate voltage from the antenna, as buffer condensers in mercury-vapor rectifiers, and as blocking condensers in series-fed tank circuits in which it is desirable to ground the tuning-condenser rotor. The condensers, which are non-inductively wound, are made in five capacities, 0.002, 0.005, 0.01, 0.05 and 0.1 μ fd. The first three are rated at 1500 volts d.c. and the latter two at 1000 volts d.c. for continuous operation. The r.f. current-carrying capacity rating is 50 amperes per microfarad at 28 and 14 mc., and 25 amperes per microfarad at the lower amateur frequencies; for example, a .05- μ fd. condenser will carry 2.5 amperes r.f. at 14 mc. The condensers are tubular in shape, ranging in size from $\frac{1}{2}$ by $1\frac{1}{2}$ inches to $\frac{3}{4}$ by $2\frac{1}{4}$ inches overall, depending upon the capacity. Wire terminals are furnished.

The new oil-impregnated by-pass condensers are a product of the Sprague Products Company, North Adams, Mass.

With the Affiliated Clubs

(Continued from page 33)

those members who are unable to attend—such as the chap who recently had to stay home from meeting to mind the baby!

Canadian Outings

The Ottawa Amateur Radio Transmitting Association held its first annual field day and ham picnic on Labor Day, September 3, near Lanark, Ontario. The big event was a hidden transmitter hunt. The transmitter, a single 112-A

PRECISION 30 times finer than a human hair

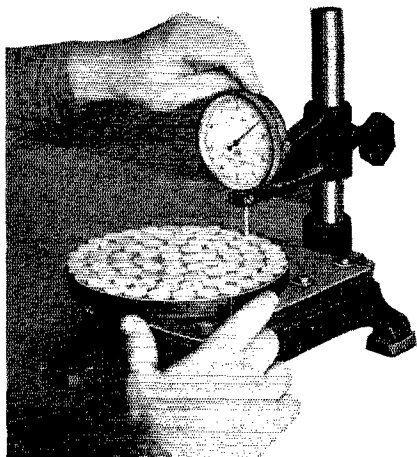

Bliley Commercial Frequency Crystals are manufactured to exacting specifications between 20Kc's and 15Mc's. Write for price list.

BECAUSE ordinary methods will not produce the exacting results demanded by Bliley standards of quality, much of this company's machinery has been specially designed by themselves.

In the Bliley plant are paralleling machines that lap to a precision of 1/10,000 inch; thirty times finer than a human hair! Testing equipment has been devised that accurately calibrates the finished crystal to a few cycles.

With such outstanding equipment it's no wonder that Bliley's have the reputation for frequency stability and high power output, and are the first choice of amateurs and engineers the world over. Your distributor carries Bliley Crystals; order from him. Bliley Electric Co., 208 Union Station Bldg., Erie, Pa., a member of the Radio Manufacturers Assn., operates under NRA.

Type BC3 mounted crystals in the 3.5, and 7.0 Mc bands having a precision of .03% supplied within 10 Kcs or any frequency from distributor's stock, \$3.95 — to exact specified Kc at slight additional cost. Bliley Crystals are sold by all progressive distributors of amateur equipment. If our distributor doesn't have your choice in stock, he can get it for you quickly; order from him.

PROFIT BY THE EXPERIENCE OF OTHERS—Thousands of Amateurs Have Read **HINTS AND KINKS**

If you haven't yet gotten a copy of this indispensable compilation of the money-saving ideas of 189 experimenters, you'll be glad to know that the original supply, exhausted in less than six months, has been replenished by a second printing. You'll find in it hundreds of good ideas which amateurs have found helpful. It will return its cost many times in money savings — and it will save hours of time. Many of these little dodges would probably never occur to you. Order your copy at once.

HINTS AND KINKS FOR THE RADIO AMATEUR

No. 10 in the A.R.R.L. series entitled The Radio Amateur's Library

EIGHTY PAGES in ATTRACTIVE PAPER COVERS
50 cents, postpaid anywhere (no stamps, please)

THE AMERICAN RADIO RELAY LEAGUE
West Hartford, Connecticut



"E. H. Rietzke
SPEAKING!"

Mr. E. H. Rietzke, President of CREI, and originator of the first thorough course in Practical Radio Engineering.



Radio Is Showing Real Progress ... ARE YOU KEEPING PACE?

The opportunity is here for you to grasp the opportunities that new Radio developments have created. But executives are particular today; they can afford to hire the best. They want only capable, technically trained men. CREI can offer you the necessary training... and educational prestige that has gained so many important jobs for our graduates.

Now Offered for the First Time — "AUDIO & ACOUSTICAL ENGINEERING"

A new series of lessons now a part of all courses... to prepare the engineer to handle practical problems arising in the design and installation of audio and acoustical work.

Just Off the Press — 44 Page Illustrated
Booklet Mailed FREE on Request

Complete details and photographs of school and equipment in our new and large catalog. Write today.

CAPITOL
ENGINEERING



RADIO
INSTITUTE

14th and Park Road, N. W.
Dept. Q-11

Washington, D. C.

CORNELL-DUBILIER

"CQ"

TO ALL HAMS

CORNELL
consistently

DUBILIER
dependable

C O N D E N S E R S

ARE NOW AT THE LOWEST PRICES IN HISTORY STOP CONDENSERS NOW SMALLER IN SIZE AND OF IMPROVED CHARACTERISTICS DUE TO NEW SCIENTIFIC DEVELOPMENTS STOP AVAILABLE FROM YOUR SUPPLIER IN ALL NINE DISTRICTS AT THE SAME LOW PRICES STOP

73 SIG W2AFS

CORNELL-DUBILIER CORPORATION

4373 BRONX BOULEVARD
NEW YORK

GULF RADIO SCHOOL

Radiotelegraphy

Radiotelephony

Radio Servicing

SECOND PORT } 1007 Carondelet Street
U. S. A. } NEW ORLEANS, LA.

IT'S A CINCH TO BUILD ROSS HULL'S 56 m. c. BEAM

or one for the 112 or 224 m. c. bands

WITH THE NEW

LYNCH ULTRA H. F.

BEAM AND TRANSMISSION-LINE KIT

This complete kit includes: 125 ft. of LYNCH HI-MHO antenna wire; 16 LYNCH U. S. NAVY STANDARD antenna insulators; 100 ft. HI-MHO light-weight transmission-line wire; 8 LYNCH U. S. Navy standard transmission-line separators; 2 LYNCHITE transposition blocks, and full instructions.

LIST PRICE \$8.50 To A.R.R.L. MEMBERS, \$5.00 net
POSTPAID ON RECEIPT OF CASH IF YOUR DEALER
CAN'T SUPPLY

You should have the dope on all the
other LYNCH HAM ACCESSORIES.
Write for FREE BULLETIN.

ARTHUR H. LYNCH, INC.
227 Fulton Street New York, N. Y.
The pioneers of noise-reducing aerials

Hartley on 3.5 mc., powered from a dynamotor and storage battery, was hidden in a thick clump of trees about a quarter mile from the picnic grounds by VE3QB, VE3MX, and VE2GP. About fifteen feet of aerial was used and the little rig put a fair signal for several miles—and some of the gang traveled that far looking for it! VE3AM and VE3MB were the victors. Other competitions included portable contest, (VE3JE first) code sending contest, (VE3XQ first) rag chewing contest (VE3SA first) (each contestant had to devour fifteen feet of gauze bandage!), and a rolling pin throw for the ladies (won by Mrs. VE3WY). The prize drawing was as usual a popular feature with few going away empty-handed. Among the speakers were VE2GP, club president, VE2DU, VE2BE, Canadian General Manager, and VE3QB, who announced the launching of a ham sheet. Much credit for the success of the affair goes to VE3QB, who made arrangements for the meeting place. A bigger and better hamfest is planned for next year.

The Hamilton Amateur Radio Club's picnic held at Grimsby Beach, Ontario was enjoyed by all. Among those present were Mrs. VE3DW, VE3QE, VE3QH, VE3HT, VE3IQ, VE3XT, VE3HP, VE3TQ, VE3JU, VE3KM, VE3SM, VE3OJ, VE3IY, and VE3SP. Much interest was shown in the 56 mc. 'phone gear of VE3SP and VE3KM.

Miscellany: The Fellsway Radio Club of Medford, Mass., operates a station, WIZO, on 7 mc. c.w., 3.9 mc. 'phone and 56 mc. 'phone and i.c.w. WIZO is located at the club house on Sullivan's Mountain in Medford. An operator is on duty every evening except Sunday and visitors and prospective members are always welcome. . . . The St. Petersburg (Fla.) Amateur Radio Club enjoyed its first hamfest on Labor Day, last. One of the most interesting features was an emergency drill in which the gang were to see how fast a transmitter could be assembled from scrap parts. A simple oscillator was in operation within half an hour. . . . The Astoria Radio Club of Long Island City issues its members a snappy bulletin called "The A.R.C. Views and News". . . Over 200 amateurs attended the first annual hamfest of the Starved Rock Radio Club, Spring Valley, Illinois. The affair met the expectations of all and left nothing to be desired.

Visit the Clubs

A good many hundred amateur radio clubs throughout the United States and Canada are affiliated with A.R.R.L. At headquarters we have recorded the addresses of these clubs, their places and times of meeting. Clubs are splendid places to get acquainted with other amateurs and to participate in interesting discussions on amateur radio. Do you want to be put in touch with a club in your vicinity? Would you like to attend a club meeting in another city you are visiting? Address the Communications Manager (enclosing 3¢ stamp, please) for data on Affiliated Clubs in your vicinity.

—E. L. B.

CANADIANS!

VALUES!!

CANADIAN NET PRICES

POWER TRANSFORMERS

HYDRO APPROVED

CTC-442 125 Watts
 425-0-425 Volts 185 Mills
 5V. 3A., 2½V. 3A., 2½V. 10A.
 Size 4½", 3¾", 3½"
 Wgt. 11 lbs., 25-60 cycle
YOUR COST \$3.98

CTC-449 60 Watts
 325-0-325 Volts 65 Mills
 2½V. 8A., 5V. 2A.
 Size 25C. 3½", 3¾", 3½"
YOUR COST \$2.98
 Size 60C. 3¾", 2¾", 2"
YOUR COST \$2.29

Transformers guaranteed for one Year against defects.



JENSEN DYNAMICS

D-9, 10" cone \$3.98
 D-15, 8" cone \$3.49
 Field 2500 Ohms

Includes output for any type tube single or PP.

Complete new stock of transmitting and receiving equipment, condensers, resistors, meters, etc.

**BIG FREE CATALOGUE!
 GET YOUR COPY!**

Distributors of

NATIONAL
 HAMMOND
 TRIPLETT
 READRITE
 I.R.C.
 CARDWELL
 YAXLEY
 AUTO-LITE
 SIGNAL
 UTAH-CARTER
 E. F. JOHNSON
 INSULINE
 SHURE
 AMERICAN
 RADIO
 MICAMOLD
 SYLVANIA

CANADIAN TIRE CORPORATION, LTD.
 625-637 YONGE ST., TORONTO MIDWAY 2486

LITTELFUSES

- INSTRUMENT LITTELFUSES, for meters, ½amp. up.
- HI-VOLT. LITTELFUSES for transmitters, etc., 1,000, 5,000 & 10,000 volt ranges, ¼ amp. up.
- NEON VOLTAGE FUSES & Indicators (TATELITES), 100, 250, 500, 1,000 & 2,000 volt ratings.
- AIRCRAFT FUSES, AUTO FUSES, FUSE MOUNTINGS, etc. Get new Cat. No. 6.

Littelfuse Labs., 4509 Ravenswood Ave., Chicago, Ill.

PANELS — BAKELITE — RUBBER — ALUMINUM

All Sizes Cut to Order BAKELITE TUBING & RODS

Drilling, Engraving & Special Work

ALUMINUM CANS—Stock sizes. Special sizes, made to order.

ALUMINUM CHASSIS—Threaded brass studs for 6/32 screws.

Length from ¼" to 6"—price 5c to 30c.

Insulating bushings Couplings in brass or Bakelite—15c

Bakelite Tubing Threaded to Specifications.

UNITED RADIO Transmuting frames and racks

MFG. CO. Est. 1923 191 Greenwich St., New York



SANGAMO ACCURATE CONDENSERS

Available in 5000 volt construction for use in short wave transmitters

Write for catalog sheet

SANGAMO ELECTRIC CO.
 SPRINGFIELD, ILLINOIS

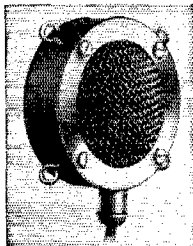

See your nearest jobber

Far-reaching in its significance, the name Astatic has become syn-

onymous with dependability. Thousands of operators the world over, using Astatic microphones have proclaimed this dependability under trying conditions. Built to withstand rough usage and adverse climatic changes without adjustment. Beautiful in appearance and constant in performance, this unit excels in the field of Radio and Public Address.

D-104 list . . . \$21.00
 Net to hams . . . \$12.60

ASTATIC MICROPHONE LABORATORY Inc.

Licensed under Brush Dev. Co., patents
 YOUNGSTOWN, OHIO

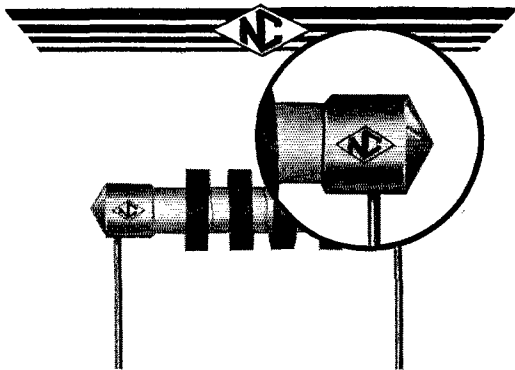

Appearance is much easier
to imitate than performance

NATIONAL COMPANY, Inc.
MALDEN, MASS.



**New QUIET VOLUME
CONTROLS and RESISTORS
for Every Amateur Purpose**

Write Dept. Q
for Catalog.

175 Verick St., New York, N.Y.
ELECTRAD

'AT' CUT CRYSTALS Now Available

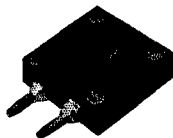

Holder included
with each crystal

The 'AT' cut quartz crystal recently developed has a temperature coefficient of practically zero and will handle more power than ordinary crystals. One-inch square 'AT' cut crystals supplied within 0.1% of your specified frequency and calibrated accurate to 0.03% are priced as follows: 1750 and 3500 kc. bands — \$7.00 ea. 7000 kc. — \$10.00. (Prices include holder illustrated.)

'X' cut PRECISION Crystals, one-inch square from the highest grade of Brazilian quartz and carefully ground for maximum power output supplied within 0.1% of your specified frequency and calibrated accurate to within 0.03% are priced as follows: 1750 and 3500 kc. bands — \$4.00 each. 7000 kc. — \$5.00. (Prices include holder illustrated.) Jacks to plug holder into — \$.15 pair.

Crystals and ovens for commercial use quoted on at your request. When ordering our product you are assured of the finest obtainable. Now in our fifth year of business.

PRECISION PIEZO SERVICE
427 Asia Street Baton Rouge, La.

A.R.R.L. All-Section Sweepstakes Contest

(Continued from page 10)

in the proper direction to assure promptest delivery). Contest messages, as with all messages must be sent complete, in proper A.R.R.L. form with city, station, number, date, address, text and signature. Those who take part may report improper message sequence or abbreviations in texts (abbreviated words are not ethical in texts). Where Sections are smaller units than states, the name of the Section should be included after the signature in originated messages to assist participants in properly crediting messages.

Example of message in A.R.R.L. form:

*Hr msg fm Springfield Mass WICCH NR 253
NOV 18*

*TO C. W. Backenstose Secy
Chester Radio Club W3BKQ
1018 Butler St Chester Penna*

**HAVE YOU TRIED OTHER HAM BANDS
IN SWEEPSTAKES**

Luce WICCH Western Mass. Section

Several different short contest messages can be written in advance to use in swapping proof-of-QSOs in proper form. Progress of competitors can be discussed. Humor and imagination inserted in texts add to the interest. We want no "73 cu!" formula QSOs. Identical-text messages (rubber-stamp type) are ruled out of the count. A different text must be sent each station. All work must fall within the contest period. Failure to provide traffic files if called upon to do so will constitute disqualification. However, participants are requested not to send in message files with their reports, but to hold them for possible call.

Contest messages do not count this year in A.R.R.L. monthly traffic totals. Since they are short and exchanged as "proof of QSO" they give excellent practice in form and offer a chance to inject some humor into texts. Of course contest traffic should not be classed with the traffic of a more important nature routed over A.R.R.L. Trunk Lines and handled through a thousand channels by individual scheduled or net arrangements. Where regular traffic on the hook is moved, and it always should be, when it can be speedily and properly routed, there is of course no necessity for creating a "contest message" for the purpose. Such regular messages count both for the contest and the monthly report.

IN GENERAL

The only competition each operator must consider comes from operators in his immediate Section. Awards are for the operator running up the best communication record for each Section (as indicated by the score). In this manner, operators in each territory are placed on a basis of equality as to DX conditions and operating opportunity.

The new R-S-T reporting system is printed on page 72 of this issue so it may be conveniently clipped out and tacked up in your shack for reference. A trial of the new system for the contest

PROMPT DELIVERY ON THE NEW 1935 PATTERSON PR-12 RECEIVER

- ★ TWO STAGES PRE-SELECTION
- ★ COMPLETELY ALL-WAVE—550 TO 8 METERS
- ★ ALL BANDS FREQ. CALIBRATED
- ★ P.P. OUTPUT
- ★ CONTINUOUS BAND SPREAD

Here are the complete prices:

	List	Net Cash	Down Payment	Monthly Payments
PR-12 Complete	\$139.50	\$83.70	\$35.75	\$11.00
XTAL PR-12 Complete	149.50	89.70	37.25	12.00

DELAWARE RADIO SALES COMPANY

EASTERN DISTRIBUTORS

405 DELAWARE AVE. WILMINGTON, DELAWARE

"GO-DEVIL"

AUTOMATIC KEY
Highest quality, lowest price. Equally suitable for beginners — or old timers. Shipped by return mail.

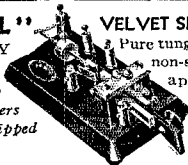

VELVET SMOOTH ACTION
Pure tungsten contacts, heavy non-skid base, beautiful appearance, rugged construction.

Guaranteed
\$6.00

A. H. EMERY 263 MILL ST. POUGHKEEPSIE, N. Y.

GRID LEAK BIAS

may be used with complete safety in even the largest ham transmitter equipped with the —
SENTINEL MAGNETIC OVERLOAD BREAKER
Automatically cuts off plate voltage instantly on overload. Heavy breaking contacts. Model A 50 to 400 m.a. Model B 100 to 800 m.a. Either \$5.85 plus 3 lbs. postage. Cash or C.O.D.

Write for free circular
DON H. MIX & CO. Box 403, Bristol, Conn.

Technical
Training Station

Phone C. W.

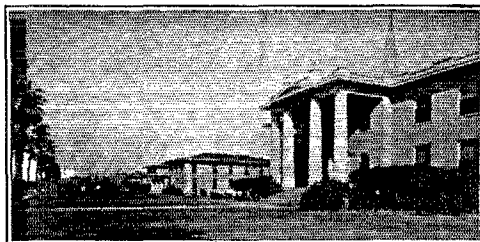

Studio Technique
Guaranteed

K P A C

500-Watt 1260
Kilocycles

In 3 to 7 months we train you to secure Commercial Telegraph Second-class, and Radiotelephone First-class government licenses. Course consists of Wireless Code, Radiophone, Microphone-Studio Technique, Service, Police, and Aeronautical Radio. We are authorized to teach RCA texts. At completion of course you receive practical studio technique experience in our commercial broadcast studios located in administration building, and experience as an operator on K-P-A-C (500-Watt Commercial transmitter located on the campus and owned and operated by the college), and WPA, 4000-Watt Commercial Wireless Station. Return coupon for details.

PORT ARTHUR COLLEGE

Port Arthur (world-known port) Texas

Name.....
Street or Box.....
City and State.....

Service +



These Aerovox oil-impregnated, oil-filled units are built for hard going and a long pull. You simply install them in your transmitter and forget them. Condenser breakdowns become a thing of the past.

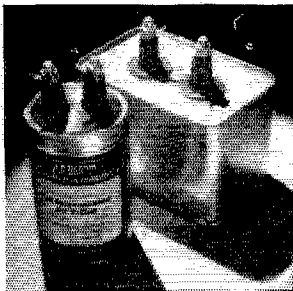

100% pure linen paper . . . finest paper dielectric available.

Sections oil-impregnated. Containers filled with oil. Best dielectric protection. Cool operation.

Special reinforcement in winding process of round can type for troubleproof performance. Clamped sections in rectangular seams can type prevents fluttering of plates.

Conservative ratings. High-tension terminals. Maximum service life the aim. No attempt to meet low price competition.

SEND FOR DATA on these new capacitors. Also latest Aerovox catalog covering entire line of condensers and resistors. Free copy of the Aerovox Research Worker . . . a monthly publication chockful of advanced radio dope . . . will be included.

AEROVOX

CORPORATION

73 Washington St.

Brooklyn, N. Y.

A NEW ELECTRO-VOICE MICROPHONE

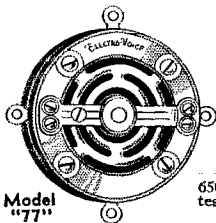

Model "77"

The ideal instrument for communication and public address. Designed for speech and music. Definitely in the quality class. Incorporates all the best and newest features. Removable buttons for easy repacking. Gold spots warranted for life. Extra heavy chromium plate. Output: -40 DB. Response: 35-6500 c.p.s. Individually oscillograph tested. Shipping weight 2 pounds.

NET PRICE: \$10.80

If your dealer cannot supply you, order direct

ELECTRO-VOICE MFG. CO., INC.

322 East Colfax Avenue

South Bend, Indiana

A.C. Electric Generating Plants

ONAN ALTERNATING CURRENT ELECTRIC PLANTS furnish the same current as city service — 110 volt, 60 cycle, A.C. Operate Radios, Water Systems, Refrigerators, all household appliances.

Size 300 to 50,000 Watts

Operate on Gasoline, Gas or Distillate. No battery used except to start engine. Ideal for places remote from electric service. For Public Address, Sound Amplification, Portable Lighting and Standby Equipment.



\$99=

Also a complete line of D.C. Models

Some Dealer's Territory Available

D. W. ONAN & SONS

455 Royalston Ave., Minneapolis, Minn.

period will enable you to give us your opinion as to its merits and demerits as well as to give the hams you work complete reports. It adds to the friendly spirit after the contest to send QSL cards. We still have the card with an S.S. broom, designed especially for the contest last year by one man who took part.

Most effective use of the available operating hours, intelligent choice of the different amateur bands, and a high degree of operating proficiency will take one a long way toward superlative results in this contest—or in any amateur radio work for that matter. Next to operating ability it is our opinion that a good receiver is most important and essential to success. Single-signal selectivity and high sensitivity will win and bring in the stations at distant points calling you. But the best equipment is only as useful as the man behind the key or mike can make it. Operating proficiency is what counts!

Logs will be checked against each other to insure fairness and accuracy in making awards. However, it is not altogether necessary that each station worked be taking part in the contest to make your points count. Any operator who needs information can be referred to this announcement. First of all, ask the operator to come through with a contest message, and take yours.

Two suggestions from the last S.S.: W4AAQ says as a reminder that a station has been worked a mark can be put in the call book. In addition to saving time this is of special help to two-operator stations. W8FLA says that each time a new Section is worked the list of Sections on page 5 of QST should be checked, to keep track of the number of Sections contacted.

THE CERTIFICATE AWARDS

Certificates will be given as a permanent record and memento of the operating result attained. A classy-looking certificate award will be given the amateur with the highest official score in each Section throughout the field organization of the League. This is a practical test of the reliability, general communicating ability, and efficiency of stations and operators.

AFFILIATED CLUB PARTICIPATION

To encourage local QSO Party participation, especially by hams who have never previously enjoyed the benefits of a contest, additional certificate awards will be made through each club where three or more individual club members, or new local hams invited by such a club, take part. Reports must be made direct to A.R.R.L., West Hartford, mentioning the name of the club, to be eligible for the affiliated-club-award. Entrants who mention their club will be eligible for both club and Section awards.

REPORTING RESULTS

Report to A.R.R.L., West Hartford, Conn., giving your list of QSO's, showing Sections, stations and total, as soon as the contest is over. Include a signed statement that the points as enumerated are correct and true. Hold message files for checking but do not send them unless

**EIMAC
150-T**

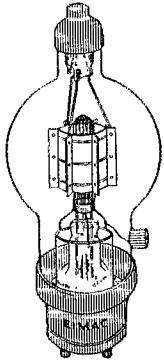

The Tube You Asked For Is Here At Last!

IN EVERY IMPORTANT FEATURE— UNSURPASSED

HERE is a tube, new and original in design. It fulfills the most severe requirements of amateur practice. High output is obtained with low grid driving power and low plate voltages. Exceptionally high vacuum increases usable filament emission and prolongs tube life. Tantalum grid and plate construction permits maintenance of high vacuum even when overloaded. Extremely low inter-electrode capacitances make for high efficiency at high frequencies. Isolated grid and plate leads, in con-

junction with elimination of internal insulators, insure freedom from arc-over or breakdown. Low voltage double-V filament reduces hum, increases filament ruggedness and life and increases mutual conductance. The large NONEX envelope, free from discoloration, allows maximum heat radiation without bulky physical dimensions. Improved 50-watt base insures rigidity and freedom from short-circuiting. "Ghost" grid structure minimizes electronic shadowing effects on the plate.

Characteristics:

EIMAC-150-T Triode

Fil. Voltage	5 V.	Fil. Current	10 A.
Rated Plate Dissipation	150 W.	Amp. Factor 13:	Max. Plate Current 200 MA.
Plate Voltage	1000 2000 3000		
Plate Resistance	2750 1900 1250		
Mutual Conductance	5800 7300 1200		
Normal Power Output (75% eff.)	150W. 300W. 450W.		
PRICE	\$24.50. Sold Only by Reputable Dealers.		

More **POWER** per dollar! Fewer dollars per hour of useful life! The result of six years' experience exclusively building transmitting tubes for ship, mobile, portable and amateur use. Unconditionally guaranteed to be gas-free, and against mechanical defects for two years.

"COMPARE AND REFLECT"

EITEL-McCULLOUGH, Inc.
San Bruno, California, U. S. A.

RADIO ENGINEERING

RCA Institutes offers a combined course of high standard embracing all phases of Radio. Practical training with modern equipment at New York and Chicago schools. Also specialized courses and Home Study Courses under "No obligation" plan.



Illustrated catalog on request

RCA INSTITUTES, INC. Dept. ST-34
75 Varick St., New York. 1154 Merchandise Mart, Chicago
Recognized Standard in Radio Instruction Since 1909

**NEW
MESSAGE
FILE**

See
Page 79

NEW High-Quality HAND-SET for 5-METER TRANSCEIVERS

The new Shure Transceiver Hand-Sets have been especially designed to meet the requirements of ultra high frequency portable and mobile radiophone equipment. The single receiver and high-output microphone transmitter are conveniently combined in a special hand-set mounting, attractively finished in rubber-tone black double-baked japan. 6-foot flexible color-coded cord:

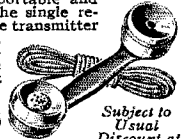

Model 6A with 70-ohm receiver.
3-lead cord, List Price... \$12.00
Model 6B with 2000-ohm receiver.
4-lead cord, List Price... \$12.50

Subject to
Usual
Discount at
Your Jobber

SHURE BROTHERS COMPANY
Microphone Headquarters
215 W. HURON STREET CHICAGO, U. S. A.

YOU Can Learn the CODE at Home— Pass Any Code Test — Talk with Real 'Hams' at 30 W.P.M.

Use **INSTRUCTOGRAPH** for *Best Results*. Code students everywhere disappointed in trying to learn the code from a Short Wave receiver, have turned to the Instructograph with pleasing results. It is almost beyond belief how quickly you learn the code and pick up **SPEED** this **EASY, NATURAL** way. Better than a personal instructor. No experience necessary. Instructions accompanying Instructograph make it **EASY** for beginners. **TERMS AS LOW AS \$2 PER MONTH**. Rent it a month. Be convinced that the quickest, easiest way to learn the code and become a real operator is with the Instructograph. Rental may be applied on purchase price if desired. Send postcard for details **NOW!** No obligation.



INSTRUCTOGRAPH COMPANY

912 Lakeside Place Dept. Q-11 CHICAGO, ILL.

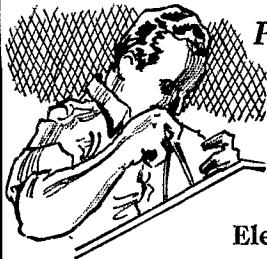

Precision . . .

is the prime factor of all

PIEZO

Electric Crystals

We guarantee our Crystals to be ground to an Accuracy of BETTER than .03% . . . BUT . . . No Crystal ever leaves our Laboratories unless it is ground to an Accuracy of BETTER than .01% of your specified frequency in order to meet OUR OWN Specifications.

Scientific Radio Service was one of the "first" to introduce "Piezo Electric Crystals" for commercial use . . . that was back in 1925 . . . and today, we still pride ourselves with the fact that our aim is toward "QUALITY" Crystals rather than quantity.

"THE CRYSTAL SPECIALISTS"
Send for Booklet and Price List

Scientific
RADIO SERVICE

124 Jackson Avenue, University Park
Hyattsville, Maryland, Q-11

LEARN RADIO

70% Placement Last Three Years

At the oldest, largest and best equipped privately owned radio operating school in the East. Western Electric and RCA tube transmitters; 180 licensed graduates placed in past three years in broadcasting, shipping, police radio, aviation, service work, etc. Course prepares for all U. S. Government Telegraph and Telephone licenses. Send for 40-page catalog. Investigate. New classes every six weeks from Sept. 10th. Open all year around.

MASS. RADIO SCHOOL, 18 Boylston St., BOSTON
R. F. TROP, Treas. — EST. 1899 — G. R. ENTWISTLE, Pres.
ONE OF AMERICA'S LEADING RADIO SCHOOLS

THE ROSS "JUPITER"

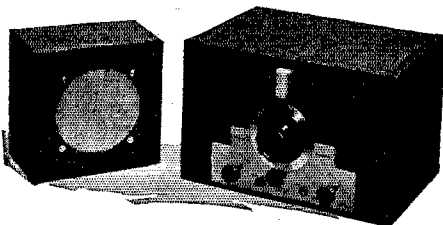

Quality at a moderate price—only \$69.50 (less tubes).
A receiver for those who demand the finest in amateur band reception.

A. H. ROSS & COMPANY
Keswick Ave. and Waverly Rd., Glenside, Pa. (Near Phila.)

and until called for. Use the form suggested herewith in reporting.

All active ham stations are invited to take part and report. You will work a new bunch of stations, make new records for your station, get a new bunch of QSL cards, have a whale of a lot of fun, meet new friends, and perhaps rate an A.R.R.L. award at the conclusion. If you are a newly licensed ham or one who has never majored in "traffic work" you will get some FB operating experience and have a chance to work with a "swell" gang of operators and real friendly fellow hams. The chances have been made as equal as they can be made for all. So do your best operating and send A.R.R.L. the results for QST mention.

Scoring system in brief:

For c.w.-c.w. and 'phone-'phone contacts:

- 1 point for each QSO when message exchanged one way.
- 2 points for each QSO when message exchange is made both ways.

For c.w. to 'phone or 'phone to c.w. contacts:

- 1½ points for each QSO when a message is exchanged in one direction.
- 3 points for each QSO when messages are exchanged both ways.

For final score:

Multiply totaled points by the number of A.R.R.L. Sections² worked, that is, the number in which at least one bona fide S.S. point or exchange has been made.

Multiply this by the proper figure indicated under the power handicap⁵.

QUESTIONS ON THE CONTEST

How short a message will prove a QSO? Five-word text. Is a long signature required? It can be shortened to nickname or station call, plus Section identification where necessary. When must Section be identified? When smaller than a state or province. Not in Iowa or Conn. for example, but in California, N. Minn., S. Minn., E. N. Y., W. N. Y., N. Y. C., L. I., E. Mass., W. Mass., etc. Signature to the example of message form is brief, but thoroughly informative if changed to "W1CCH W. Mass."

What about the address? Call signal, city and state must be given, and are adequate on originator to addressee messages. Where relayed through even one station, a complete address, with name, street, and number, should always be given to facilitate delivery.

Can HQ staff stations take part? Yes, but the operators are ineligible for awards. W1MK will send the usual addressed transmissions to members, but in the remaining time will work with contestants whenever possible to add the point or Section or those in the S.S.

What can I write texts about? Anything at all. See almanac, magazines, etc. Ask about apparatus, DX, conditions, altitude, phone work, frequency bands, new regulations, N.C.R., A.A.R.S., commercial operating, high quality signals, transcons, club membership, the New Deal, favorite sport, occupation, age, temperature, the R-S-T system, Trunk Lines, OKS/OPS appointment, U.H.F., score tubes, QST articles, etc.

Is it necessary to be a League member, to take part? No, any ham who follows the rules and reports is eligible for mention and awards.

REPORTS MUST BE RECEIVED AT A.R.R.L. HDQ. FROM ALL STATIONS EXCEPT THOSE IN ALASKA, HAWAII, AND P. I. ON OR BEFORE NOON DECEMBER 20, 1934. TO BE CONSIDERED IN THE RESULTS OR CERTIFICATE AWARDS. FROM THOSE OUTLYING POINTS NAMED REPORTS MUST BE RECEIVED ON OR BEFORE JANUARY 17, 1935.

MAIL YOUR REPORT IMMEDIATELY AT THE END OF THE CONTEST TO AVOID DELAY AND INSURE THAT YOUR RESULTS ARE CREDITED AND KNOWN THROUGH QST.

W4 Strays '35

W4MS reports that W4BGA is thinking of getting a crystal filter for his FB7A so he can tune in one automobile ignition at a time!

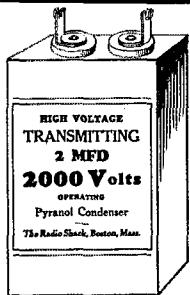

The Radio Shack PYRANOL TRANSMITTING CONDENSERS

\$ 2.50

AMATEURS — Laboratories, Broadcast Stations have bought these condensers, recognizing in PYRANOL one of the finest Dielectrics yet evolved for Filter Condensers.

**2 MFD.
2000
VOLTS**

Most important we wish you to know that We have made these available at a very low price

V. T. 203 A Graphite Anode \$9.00 GUARANTEED BALDWIN Type C Phones Per Pair... \$2.50	TRIAD TUBES 210.....\$1.25 281..... 1.25 250..... 1.25 841..... 2.50 83..... .55 46..... .60 DE FOREST 281...95	Complete stock of PARTS for the amateur laboratory and broadcast station Gammatron 354 \$24.50	General Radio Coil Forms 677Y.....50c 20-40-80 M 677U.....75c 30 TURNS 4" DIAMETER	R. S. 830-40 WATTS 7.5 Fil. \$5.95 1000 V. Plate 866 TUBES Heavy Duty \$1.69 CHOKES 200M-20H \$2.25 250M-30H 2.50 150M-30H .99	
					KEYING RELAY 5-15 Volts AC or DC \$3.30 1500 Watts 2½ V. 12 AMP. TRANSFORMER FOR 866's \$1.25
BLILEY Mtd. xtal \$3.95	Sylvania 210 \$5.75 830 8.75	50-Watt SOCKET \$1.20	National 40% Discount		
THE RADIO SHACK 46 BRATTLE STREET • BOSTON				SEND M. O. OR CHECK MAIL ORDERS FILLED	

CQ-AMATEURS of the West

Just off the Press, send for your copy

1934 CATALOG

All Nationally advertised parts for Transmitting and Receiving
Lowest Prices

RADIO SUPPLY CO.

H. A. DEMAREST, President
912-14 So. Broadway Los Angeles, Calif.
(W6FBI, located in Building)

HIGH FIDELITY!

with the new SHURE 43 Series
"Wave-Equalized"*

CONDENSER MICROPHONES

Cavity Peak Completely Eliminated! High-Frequency Range Extended a Full Octave!

Yes — true high fidelity, achieved by Shure Engineers through "wave-equalization." Establishes an absolutely new standard of condenser microphone performance!

Available in 3 Models. List prices as low as \$150.00. *Trade Mark Registered
A request on your letterhead will bring complete information

SHURE BROTHERS COMPANY

Microphone Headquarters
215 W. HURON ST. CHICAGO, U. S. A.



POWER and PORTABILITY

19 TYPE CLASS B MODULATED

56 M.C.

TRANSCIVER

As described in June Q.S.T. by Frank Jacobs, W2BSL

Equivalent of 5 Tubes — One 30, Two 19's
Strong voice when Flea Power Signals fade out. Completely dry battery operated. 2 volts filament. 135 volts plate. Fil. voltage control compensates for battery deterioration. Rugged crackle finish metal case — 10 x 7 x 5 inches. Weight 7½ pounds. Vernier dial. — Cardwell tuning condenser.

All Orders Receive the Personal Attention of the Original Designer

Net Price \$22.50 — 3-Raytheon Tubes, \$1.90
20% with order — balance C.O.D.

RADIO TRANSCIVER LABORATORIES

Richmond Hill, N. Y.
8427-105 Street

BIRNBACH Standoffs

All Sizes 5/8" to 4½"

MOST complete line of high-grade, highly-glazed porcelain insulators. 56 new numbers include standard and "Feed-Thru" models in plain, jack or wingnut types. Nickel-plated brass hardware. Cork mounting washers.

Demand BIRNBACH Standoffs for safety!

Write for Bulletin Q-11

BIRNBACH RADIO CO., INC.

145 Hudson St., New York



HAM-ADS

(1) Advertising shall pertain to radio and shall be of nature of interest to radio amateurs or experimenters in their pursuit of the art.

(2) No display of any character will be accepted, nor can any special typographical arrangement, such as all or part capital letters be used which would tend to make one advertisement stand out from the others.

(3) The Ham-Ad rate is 15c per word, except as noted in paragraph (6) below.

(4) Remittance in full must accompany copy. No cash or contract discount or agency commission will be allowed.

(5) Closing date for Ham-Ads is the 25th of the second month preceding publication date.

(6) A special rate of 7c per word will apply to advertising which, in our judgment, is obviously non-commercial in nature and is placed and signed by a member of the American Radio Relay League. Thus, advertising of bona fide surplus equipment owned, used and for sale by an individual or apparatus offered for exchange or advertising inquiring for special equipment, if by a member of the American Radio Relay League takes the 7c rate. An attempt to deal in apparatus in quantity for profit, even if by an individual, is commercial and takes the 15c rate. Provisions of paragraph (1), (2), (4) and (5) apply to all advertising in this column regardless of which rate may apply.

Having made no investigation of the advertisers in the classified columns, the publishers of *QST* are unable to vouch for their integrity or for the grade or character of the products advertised.

MICROPHONE and meter repairs. Low prices. Quick service. Sound Engineering Corp., 416 N. Leavitt St., Chicago, Ill.

QUARTZ—Direct importers from Brazil of best quality pure quartz suitable for making piezo-electric crystals. Diamond Drill Carbon Co., 719 World Bldg., New York.

RADIO engineering, broadcasting, aviation and police radio, servicing, marine and Morse telegraphy taught thoroughly. All expenses low. Catalog free. Dodge's Institute, Byrd St., Valparaiso, Ind.

SWAP Harwood baritone saxophone for FB7, similar superhet, or xmitter parts. W9UK, 1537 1/2 Tennessee, Lawrence, Kans.

TRANSFORMERS—quotations given. Frank Greben, W9CES, 2012 S. Peoria St., Chicago, Ill.

SELL—bargain transmitter, 47 oscillator, 46 buffer, 10 amplifier, complete with meter, crystal, tubes, power supply in real nice cabinet. W4APF, G. D. Campbell, Johnson City, Tenn.

HAM receiver with two 58s, 27; 40, 80 meter band-spread coils. Well built, \$12. W8GVN, Nunica, Mich.

QSLs, two colors. Samples. Printer, Corwith, Iowa.

COMPLETE file *QSTs* to 1932 inclusive. \$100. cash. W1GY.

QSLs! **QSLs!** Newest designs! Modernistic! Cartoons! Stamp for samples! W8DED, Holland, Mich.

QSL cards, two color, cartoons, message blanks, stationery, snappy service. Write for free samples to-day. W1BEF, 16 Stockbridge Ave., Lowell, Mass.

SELL—Kennedy Universal receiver, type 110-175 to 26,900 meters. G. E. 860 tube ten dollars. W4OA.

INSULATION, wire, varnishes, supplies, etc. Send 3¢ stamp for bulletin. Autopower, 418 S. Hoyne Ave., Chicago.

TEN practical and low-cost changes converting Dodge 12-V, Ford T.A., Chevrolet Delco 6-V, generators into 100-500 watt capacity a.c. generators or into 32-110-V d.c. motor or generator. Dodge is 500-W self-excited. All in one book illustrated with complete simplified instructions and drawings for only \$1. Autopower, 416 S. Hoyne Ave., Chicago.

WANTED—16mm. movie equipment. Trade radio parts and tubes. No junk wanted—no junk to trade. W7KV.

SELL complete 50 watt class B rack-panel 160 meter fone transmitter. \$65 takes it. W8BHE, Bucyrus, Ohio.

866's—1000 hour guarantee \$1.49. Eleven other types reasonable. Howard Radio, 314 N. Pine Ave., Chicago.

TRADE—higher bookkeeping, accountancy course worth \$75. For FBXA or what? W5BTX, Fayetteville, Ark.

SWAP tenor banjo, tenor guitar, banjo uke for ham receiver or what have you? W2GQQ.

TRADE latest RCA operator's course for set analyzer. W9HNS, Nopeming, Minn.

TWO complete public address systems, Wright-DeCoster speakers and horns, microphones, several crystals, RCA condenser head. W9DOQ, Route One, Duluth, Minn.

SPECIAL glass feeder spreader, 12 cents each, prepaid on 10 or more. Haring Mfg. Company, 220 Ambler St., Quakertown, Penna.

NEAT 160-m c.c. phone, 15W, like May *QST*, 24-A-59s, line reports, complete \$35. W9REG, Carl Fastje, Denison, Iowa.

CLASS B transformers—Universal for two or four 46s, 210s, 800s, RK118s, etc., \$7.75 pair postpaid anywhere in United States. 70 watts of audio from 46s. Write for details. W8UD, Douglas, Mich.

CRYSTALS \$1.35 Hipower Oscillators 3500-1700 Kc. Bands. Close to your specified frequency, 7000 Kc. \$4.25. Crystal blanks 65¢. Ready for delivery the New Hipower Molded bakelite holder. Threaded top cap no screws. Mounts in tube socket. We supply complete with mounting \$1.00. The Best holder buy on the Market. Send for price list and descriptive literature. Immediate delivery. No Waiting. Crystals for Broadcast and commercial use. Prices on application. Hipower Crystal Co. 3607 N. Luna ave. Chicago, Ill. You cannot buy a better crystal than Hipower at any price.

SELL—PP45 xmt, tubes, power supply, \$10. W2HNQ, 113 W. 57th St., New York City.

SILVER 5-B complete; tubes, crystal, speaker, \$48 prepaid. Also many parts. W2AEB.

FOR sale—custom built Scott DeLuxe and Silver Marshall 727 SW all wave superheterodynes. Want band spread National, Patterson, McMurdo-Silver or similar receiver. Glenn Watt, Chanute, Kans.

CRYSTALS: Guaranteed excellent oscillators, 160 or 80 meters, your approximate frequency \$1.35 postpaid. Crystal Maker's blanks 1"-65¢ dozen \$8.00, 100-30.00. Irregular shapes 25¢. Improved dust-proof Bakelite holders, non-exposed 1 1/4" silvered electrodes, plugs into G.R. or tube socket mountings, any position, 75¢-dozen \$5.40. Fisher Laboratory, 4522 Norwood, San Diego, Calif.

QSLs, W8AXD, Smethport, Penna.

CRYSTALS, 160-80 meter. Trade for tubes, meters, transformers. Bill Threm, W8FN, 4021 Davis Ave., Cheviot, Ohio.

QSLs by Maleco. Finest in country, Free samples. Maleco, 1512 Eastern Parkway, Brooklyn, N. Y.

SELL—47 oscillator 46 doubler, \$15, 59 Tritet oscillator, 841 amplifier, \$20, 160 meter phone, \$25. All items complete with power and crystal controlled. W8ANO.

CRYSTALS—160-80 meters, within three kc., \$1.50. Guaranteed strong oscillators. Vollmer Radio Lab., 5126-35th St., San Diego, Calif.

COIL forms grooved 5¢ each. Machining of all kinds at reasonable rates. T. Porcher, 7708 Navajo St., Philadelphia, Penna.

SAVE money on racks. We build to your requirements. Send sketch for free estimate. W2EZR, Kay Iron Works, 1211 Wyatt Ave., New York City.

CRYSTALS: 1" x or y, guaranteed, prompt service, \$1.35. W9HWE.

CRYSTALS: eighty meters, guaranteed, 1" x. Within three kilocycles, \$1.95. Standard holders, 75¢. "Ham Crystals." W2DBQ, 1104 Lincoln Place, Brooklyn, N. Y.

QST back numbers for sale. Schreiber, 630 Lexington Ave., New York.

SELL—Esco mg 1000V 500W, \$30. *QST* April '33 super with tubes, \$30. Wanted—burned out meters. W9ERU.

FOR sale—1000 watt transformers, 2000, 3000 volts each side c.t., \$11. 15 Henry choke, 500 mils, \$10. W3CGA.

WHAT the Amateur needs. Some place where he can sell for cash, trade for other merchandise, or buy standard or used parts and sets at bargain prices. We offer these services. Active Hams in charge 9HWF 9HWD 9FIS. Largest stock of Ham parts in Mid West. National Hammarlund Collins Biley McMurdo-Silver Cardwell Sylvania Ward-Leonard Thordarson Cornell-Dubilier. Walter Ashe Radio Co., St. Louis, Mo.

SELL: Vibroplex and case, \$6; 750-1000V Acme transformer, \$6; six 1 mfd 1750V condensers, \$4.50; ten years *QST* 1922-1932, 3 copies missing. Make offer. E. S. Clark, 1205 South Braddock Ave., Pittsburgh, Penna.

CRYSTAL blanks y cut, 50¢. Good quartz. W9DGH.

SELL—pair new unused Western Electric 276-A hundred watters, \$25. W8JYP.

SELL or swap—converter; sw receivers; guns. Want 852 or what have you? Riley Parsons, W8BXV, Old Forge, N. Y.

GUARANTEED crystals. Exact frequency, \$3. Harry Sonneborn, W9APV, LaPorte, Indiana.

CRYSTALS: Guaranteed near specified frequency, \$1.25. Calibration 99.8% accurate. Dust-proof holders, 75¢. Ed. M. Hlavaty, Western Springs, Ill.

204A sell or trade; want 849. Ralph Cook, Bucyrus, Ohio.

SHORT wave listener's cards, *QSLs*. New designs. Real prices, \$0.0000. W8ESN, 1827 Cone, Toledo, Ohio.

METERS repaired expertly at reasonable rates. Electrical Instrument Labs., 1542 Hertel Ave., Buffalo, N. Y.

FBs, Teleplexes, Omnigraphs, meters, receivers, Vibroplexes. Bought, sold, traded. Ryan Radio Co., Hannibal, Mo.

CUSTOM built equipment using your parts if desired. Get our quotation before starting that new all-band transmitter. Barker & Williamson, 50 W. Lancaster Ave., Ardmore, Penna.

POSTPAID—used, perfect: Jewell 3", 0-5 TC ammeter, \$6.75; 2-RCA845s, \$7.50 each. Facent phonopickup, \$4.75. W9GDB, Milford, Nebraska.

RECEIVER in cabinet, June QST circuit, \$8.75. W9DQH.

NEED cash—sacrifice 500 watt crystal transmitter complete, including 3 power packs, \$300. Real quality. Details and photo on request. Act quickly—this won't last long! W9EGU.

BARGAINS—Kodak, diamond cuff-links, SW midget, accordion and cash for receiver, ham experimenters apparatus. Your satisfaction. Details letter. "Gradioland," Box 19, Crawford, Georgia.

SILVERED—your crystal silvered by expert, \$1; two for \$1.50. Redondo Mirror Co., 400 N. Helberta St., Redondo, Calif.

COMPLETE training for amateur operator's license, \$1.50 per week. N. Y. Wireless School, 4 West 105th St., Clarkson 2-7456.

AMATEUR equipment manufactured to order. Holmes C. Miller, Box 105, Palo Alto, Calif.

THIRTY book "ham" library, \$3.95! 12 issues "R/9", 12 issues "Radio", "Kruse's Radiophone Guide", "R9 Sigs!—Angle Radiation", "Radio's Handbook", and three smaller books. Foreign rates on request. "R/9", 1455 Glenville, Los Angeles.

NEW "R/9" increased in page size—twice as many pages. Kruse now Technical Editor (formerly "QST" Technical Editor). \$1.50 yearly (two years, \$2.50) to U.S.A., Spain, independent American countries. Elsewhere, \$0.75 extra yearly. "R/9", 1455 Glenville, Los Angeles.

NEW, unused Amperite velocity mike, \$12. Won in prize drawing. W9LPZ.

WIBIC selling plenty of surplus equipment. Write for list.

CALLBOOKS—new Fall 1934 Radio Amateur Call Books, hundreds of new DX hams, many pages of late W and VE calls is yours for \$1.10. Four issues for \$3.65 (in foreign countries \$1.20 and \$3.90, postpaid). W9FO-610 S. Dearborn, Chicago.

CRYSTALS, guaranteed. 160-80 meter, 1/2 to 1", X or Y, within 10 kc., \$1.35. 1", within 2 kc., \$2.25, oscillating blanks 75¢, blanks from the saw 50¢, grinding instructions 25¢, plug-in holders, \$1. Wm. Threm, W8FN, 4021 Davis Ave., Cheviot, Ohio.

IN stock—lowest prices: All National, Patterson, Hammarlund, RME9D, Silver, Skyriders receivers. Trade-in your receiver. All Collins, Sylvania, Thordarson, National Hammarlund, Cardwell, Taylor, Triplett, Trimm, Johnson, Cornell-Dubilier, Bliley, others. Code machines rented. Used apparatus sold, traded. Write. Henry's Radio Shop, W9ARA, Butler, Mo.

HIGH level values. Power, filament, Universal Class B transformers. Reactors, Relay racks, Edison batteries. See October hamad. Rectifier Engineering Service.

50 Watters, \$7.50; 203As and 854s, new. Amateur Service, Fairview, N. J.

CARBON anode 50 watt tubes, \$9.75 each. New, first quality and fully guaranteed. VTE Laboratories, Ridgefield, N. J.

3000-4500 mile QSOs by making two small changes in present Zepp antenna. Specify exact frequency. Technical instructions, 25¢. George Leldahl, W3DGS, 7012 Gillespie St., Philadelphia, Penna.

\$4.95—25W transmitters. Designers, manufacturers of short wave receiving, transmitting equipment. Radio Service Labs., Fort Wayne, Ind.

QSLs. All original and FB designs! Two color. 75¢ per hundred. Stationery, etc. Free samples. W2FJE, 151 DeKalb Ave., Brooklyn, N. Y.

ALL sizes of class B and power transformers, etc., transmitters, trade or sell. Need FB7. W9KQO, Topeka, Kans.

SELL FB7 with tubes, 3.5 mc. coils, power pack, \$35 cash. Brand new. G. Scharfenberger, 191-21 Terrace Ave., Hollis, New York City.

W2ATQ must sell. Amateur and broadcast parts, tubes, misc. special equipment. Write for list. 2473 Elm Place, Bronx, New York City.

TRANSFORMER 4400V c.t. kilowatt, \$12. W9ERU.

ZEELY selling out. Hundreds of parts, such as Cardwell 2,000 volt transmitting condensers, \$2.75, UP1016 transformer, 1/4 kw, 2000 volts, \$12.00, meters, tubes, etc. List on request. Abbo, 40 Horatio St., N. Y. C.

WANTED—back numbers of QST from beginning of publication to January, 1924. Kindly quote each volume of twelve issues separately and state condition of copies and lowest cash price. Sumner B. Young, 705 First National, Soo Line Bldg., Minneapolis, Minn.

FIVE day free trial—New 1935 receivers. Patterson PR-12, a new 12 tube S.S. receiver, 2 stages pre-selection. Guaranteed lowest price. Sargent "All-Wave Explorer," 9 tube super-het, 13-560 meters, pre-selection, band spreader calibrated megacycles, air-plane dial, crackle cabinet, built-in dynamic speaker, Complete \$69.50. Sargent 8-34, 8 tube super-het 15-560 meters, Complete \$49.50. Marine model 15-1500 meters complete \$57.50. McMurdo-Silver 5C. Complete \$74.70, with crystal \$83.70. RME-9D Special. Sargent 3 tube Amateur Special, kit \$15.75, wire \$19.75. Patterson pre-selector \$17.64. New 100 watt Phone-C.W. transmitter complete with 1400 volt power supply crackle cabinet \$119.70. Turner Crystal microphone. Chromium stand free, \$13.72. Bliley Crystals mounted holder \$3.95. Everything for the "Ham" Raytheon, Sylvania, Taylor, Heintz & Kaufman tubes, Haigis, Lifetime, Johnson, Go-Devil, Sprague, Trimm, etc. Lowest prices. We pay transportation charges. Write for descriptive folders also latest bulletin "Amateur Transmitter." See our display ads R/9. L. I. Marine & Electric Co. 163-18 Jamaica Avenue, Jamaica, New York.

1000W transformers (GB) 1100-2200-4400 volts each side center tap. Same as hundreds sold A.R.R.L. members. Dawson, 5740 Woodrow, Detroit, Mich.

QSLs—SWLs, W6DOU, Hayward, Calif.

Radio Operating Radio Servicing—



Prepare for the new Government Radio Operating license examinations; Radio Operator, Marine and Broadcasting. Also Radio Amateur Telegraph and Telephone. Resident courses.

Write for Booklet

NEW YORK YMCA SCHOOLS
4 West 63rd Street, New York City

NEWARK



Offers these typical
bargains

Aerovox	Thordarson 210 Transformer
Budd	2-7 1/2 volt @ 2 1/2 amp. 1-3 volt @ 7 amp.
Cardwell	550-0-550 at 140 MA. \$1.95
Electrad	Thordarson T2387
Hammarlund	2000-3000 C.T. 300-VA. 23 lbs. \$7.45
ICA	Thordarson T2230
Johnson	115 volt Pri. 7 1/2 volt @ 4.7 amp. \$1.95
Lynch	Thordarson T1998B choke
McMurdo	20 H. @ 200 MA. \$1.25
Silver	Chicago Transformer
Ohmite	2 1/2 volt @ 10 amp. for 866's. \$.95
RCA	Thordarson T2099 choke
Raytheon	Double 25 H. 150 MA. each. \$1.10
Readrite	Thordarson T3624E
Sungamo	730 V. C.T. @ 100 MA.
Sylvania	2 1/2 V. @ 3 amp. 2 1/2 V. @ 9 amp. 5 V. @ 2 amp. Static shield. \$2.45
Thordarson	Thordarson T3952B
Triplett	345-0-345 @ 105 M.A.
and others	2 1/2 volt @ 12 amp. 5 Volt @ 2 amp. \$1.95
	15 Watt 210 Transmitting tubes @ \$.75
	Corp. of America 2 mid. @ 600
	volts. \$.49
	R. C. A. 800 Tube. \$10.00
	R. C. A. 866A Tube \$5.00
	R. K. 20 \$15.00
	Sylvania 830B \$10.00

No Substitutions—4-Hour Service

NEWARK ELECTRIC CO.

226 W. Madison St., Chicago, Ill.

JOHN WALLACE, Technical Advisor

SEND
for
FREE
Catalog

Your Nearest Dealer

Your nearest dealer is entitled to your patronage. You can trust him. He is equipped with a knowledge and understanding of amateur radio. He is your logical and safe source of advice and counsel on what equipment

Patronize the dealer nearest you—

<p>ALLENTOWN, PENNSYLVANIA Radio Electric Service Co. 1024 Hamilton Street Complete stocks transmitting equipment</p>	<p>CHICAGO, ILLINOIS Mid-West Radio Mart 520 S. State Street All standard lines carried in stock</p>
<p>BALTIMORE, MARYLAND Radio Electric Service Co. 303 W. Baltimore Street Everything for the amateur</p>	<p>CLEVELAND, OHIO Northern Ohio Laboratories 2073 West 85 Street Wholesale Distr. for National, Hammarlund, Thordarson, Cardwell</p>
<p>BOSTON, MASSACHUSETTS Nutter & Cross, Inc. 99A Milk Street All OMs, OWs, and YLs welcome — W1HRF</p>	<p>CLEVELAND, OHIO Radio Servicemen's Supply Co. 206 Prospect Street Wholesale Distributors catering to Amateurs, Dealers, Servicemen</p>
<p>BROCKTON, MASSACHUSETTS Ware Radio Supply Company 913 Centre Street Hammarlund, Sylvania, Ohmite, Raytheon, Triplett Meters</p>	<p>DENVER, COLORADO Inter-State Radio & Supply Co. 1639 Tremont Place Amateur Radio Headquarters in the Rocky Mountain Region</p>
<p>BUFFALO, NEW YORK Dymac Radio 359 Capen Blvd. — Tel. Univ. 9380 Complete Stock Amateur Parts — Standard Discounts — W8AWK</p>	<p>DETROIT, MICHIGAN Radio Equipment Sales Co. 14036 Woodward Avenue, Highland Park A complete stock of amateur, shortwave and service parts</p>
<p>BUFFALO, NEW YORK Kronson Service Company 143 East Genesee Street Western New York's largest wholesale distributors — W8EHF</p>	<p>DETROIT, MICHIGAN Radio Specialties Company 171 E. Jefferson Avenue Ham Supplies — National & Hammarlund Sets and Parts</p>
<p>CHICAGO, ILLINOIS Allied Radio Corporation 833 West Jackson Blvd. Complete standard lines always in stock — W9NRV — W9RZ1</p>	<p>DETROIT, MICHIGAN Serlin 1419 Broadway Detroit's Pioneer Radio Merchants</p>
<p>CHICAGO, ILLINOIS Chicago Radio Apparatus Company 415 South Dearborn Street (Est. 1921) W9RA and W9PST — Amateurs since 1909</p>	<p>ERIE, PENNSYLVANIA Jordan Radio Laboratory 1019 East Fifth Street Amateur, service parts, including Bliley, National, Raytheon. W8CXG</p>
<p>CHICAGO, ILLINOIS Newark Electric Company 226 W. Madison Street Chicago's oldest radio parts store — established 1921 John T. Wallace, Technical Adviser</p>	<p>HARTFORD, CONNECTICUT Radio Inspection Service Company 227 Asylum Street Yes, we'll take your old set in trade</p>
	<p>HOUSTON, TEXAS Straus-Frank Company Distributors for nationally advertised amateur products RCA-DeForest transmitting tubes</p>
	<p>JACKSONVILLE, FLORIDA Glover Weiss Co. Radio Headquarters for Southeast Distributors: RCA Victor, Stromberg-Carlson, Standard Ham Lines</p>
	<p>KANSAS CITY, MISSOURI Burstein-Applebee Company 1012-14 McGee Street "Specialists" in supplies for the Amateur and Serviceman</p>

This advertisement is paid for by the firms listed above. Qualified dealers

Is Your Best Friend

you should buy. His stock is complete. He can supply your needs without delay. His prices are fair and consistent with the high quality of the goods he carries. He is responsible to you and interested in you.

You can have confidence in him

<p>KANSAS CITY, MISSOURI Radio Laboratories 1515 Grand Avenue Amateur Headquarters — Complete Stock — Quality Parts</p>	<p>ST. LOUIS, MISSOURI Walter Ashe Radio Company 1100 Pine Street W9FIS in charge of the oldest and largest parts store in St. Louis</p>
<p>LOS ANGELES, CALIFORNIA Pacific Radio Exchange, Inc. 729-31 South Main Street Most completely diversified stock of amateur equipment in the West</p>	<p>ST. PAUL, MINNESOTA Lew Bonn Company 2484 University Avenue Rex L. Munger, W9LIP, Sales Engineer Radio Wholesaler Complete Stock</p>
<p>MANCHESTER, NEW HAMPSHIRE Radio Service Lab. of N. H. 1008 Elm Street — Tel. 218-W Branches — Portland, Me. and Barre, Vt.</p>	<p>SAN ANTONIO, TEXAS Straus-Frank Company Distributors for nationally advertised amateur products RCA-DeForest transmitting tubes</p>
<p>MILWAUKEE, WISCONSIN Radio Parts Company, Inc. 332 West State Street Complete stock Nationally Known products</p>	<p>SAN FRANCISCO, CALIFORNIA Offenbach Electric Company, Ltd. 1452 Market Street "The House of a Million Radio Parts"</p>
<p>NEWARK, NEW JERSEY Kaltman & Romander 62 Court Street Drop in for an over-counter QSO</p>	<p>SPRINGFIELD, MASSACHUSETTS T. F. Cushing 349 Worthington Street An amateur, endeavoring to sell good parts</p>
<p>PEORIA, ILLINOIS Klaus Radio & Electric Co. 707 Main Street Amateur Radio Department</p>	<p>SYRACUSE, NEW YORK Roy C. Stage, W8IGF Complete stock of standard Ham & BCL parts Standard Discounts. Free technical service</p>
<p>PHILADELPHIA, PENNSYLVANIA Consolidated Radio Corp. 612 Arch Street Ham receivers, Transmitting tubes, Collins Transmitters, etc.</p>	<p>TORONTO, CANADA A & A Radio Service Supply 101 Queen Street, West Canada's foremost radio supply house</p>
<p>PHILADELPHIA, PENNSYLVANIA Freeland Radio Supply Co. 5 N. 7th Street "If it's radio we have it"</p>	<p>TORONTO, CANADA Wholesale Radio Company, Limited 1133-39 Bay Street Canada's Largest Amateur Supply House</p>
<p>PHILADELPHIA, PENNSYLVANIA Radio Electric Service Co., Inc. N. E. Cor. Seventh & Arch Sts. All nationally advertised lines in stock</p>	<p>TRENTON, NEW JERSEY American Radio Co. 5 N. Broad Street Central Jersey's leading radio parts store</p>
<p>PHILADELPHIA, PENNSYLVANIA Eugene G. Wile 10 S. Tenth Street Complete Stock of Quality Merchandise</p>	<p>WASHINGTON, D. C. George's Radio Co. 816 F Street, N.W. Washington's largest distributor of radio parts</p>
<p>PROVIDENCE, RHODE ISLAND W. H. Edwards & Company 32 Broadway, Room 23 Amateur Equipment — National, Hammarlund, RCA Tubes</p>	

are invited to apply for rates, etc., to Advertising Department, QST

You Are Protected When You Buy From QST Advertisers

“Advertising for QST is accepted only from firms who, in the publisher’s opinion, are of established integrity and whose products secure the approval of the technical staff of the American Radio Relay League.”

Quoted from QST’s advertising rate card.

Every conceivable need of a radio amateur can be supplied by the advertisers in QST. And you will know the product has the approval of the League’s technical staff.

For Your Convenience

QST’S INDEX OF ADVERTISERS IN THIS ISSUE

Aerovox Corporation.....	86
Allen-Bradley Company.....	86
Astatic Microphone Laboratory.....	83
A.R.R.L. Application Blank.....	75
Handbook.....	71
Binder.....	72
Hints & Kinks.....	81
Publications.....	65
Supplies.....	79
Birnbach Radio Company.....	89
Bliley Electric Company.....	81
Burgess Battery Company.....	1
Cameradio Company.....	74
Canadian Tire Corporation.....	83
Candler System Company.....	78
Capitol Road Engineering Institute.....	81
Cardwell Manufacturing Corp., Allen D.....	63
Central Radio Laboratories.....	60
Collins Radio Company.....	Cov. 2
Cornell-Dubilier Corporation.....	82
Delaware Radio Sales Company.....	85
Delta Manufacturing Company.....	80
Eitel-McCullough, Inc.....	87
Electrad, Inc.....	84
Electro-Voice Manufacturing Company.....	86
Emery, A. H.....	85
General Electric Company.....	61
General Radio Company.....	62
Gross Radio Company.....	95, 96
Gulf Radio School.....	82
Hammarlund Manufacturing Company.....	2
Hygrade Sylvania Corporation.....	4
Instructograph Company.....	87
Johnson Company, E. F.....	74
Kaltman and Romander.....	64
Leeds.....	73
Littelfuse Laboratories.....	83
Mallory & Co., R. P.....	69
Massachusetts Radio School.....	88
Mix & Company, Don H.....	85
Mueller Electric Company.....	66
National Company.....	59, 72, 84, Cov. 3
Newark Electric Company.....	91
New York Y. M. C. A.....	91
Onan & Sons, D. W.....	86
Port Arthur College.....	85
Precision Piezo Service.....	84
RCA Institutes, Inc.....	87
RCA Radiotron Company.....	Cov. 4
Radio Shack.....	89
Radio Supply Company.....	89
Radio Transceiver Laboratories.....	89
Raytheon Production Corporation.....	68
Ross & Company, A. H.....	88
Sangamo Electric Company.....	83
Scientific Radio Service.....	88
Shure Brothers Company.....	87, 89
Signal Electric Mfg. Company.....	80
Teleplex Company.....	76
Triplett Electrical Instrument Co.....	70
United Radio Manufacturing Company.....	83
Ward Leonard Electric Company.....	78
Weston Electrical Instrument Corp.....	77
Wilcox Radio Sales.....	76
Yaxley Manufacturing Company.....	69

OUR EXPORT DEPARTMENT OFFERS YOU PROMPT, INTELLIGENT SERVICE AND FREE EXPORT PACKING

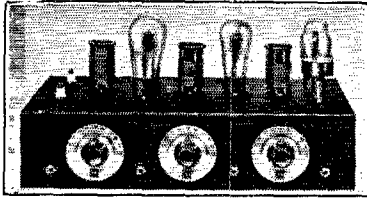

GROSS C C TRANSMITTER — OUTPUT 25-30 WATTS

The "CW-25" transmitter kit due to its low cost makes it possible for anyone to own a modern crystal controlled station. A schematic hook-up and parts layout sheet as well as tuning instructions are furnished, thus enabling the most inexperienced operator to wire and put the set on the air, for real results. The "CW-25" is supplied with a shrivel finished sturdy metal chassis under which all parts are mounted, making the wiring and components dustproof. A plug-in crystal holder is furnished with the kit. Only one milliammeter is required for tuning the transmitter and each stage is provided with a jack for this purpose. The "CW-25" uses one '47 as crystal oscillator, one '46 as buffer or doubler and two '46's in the amplifier stage, set of three coils supplied with kit for 20, 40, 80 or 160 band. **\$13.95**

Additional coils 75c each. Complete kit, less tubes and crystal.....

The "EAGLE" Three-Tube Short Wave Receiver

"Band Spread" over any portion of the tuning range—only finest material used thruout. Employs one '32 R.F., one '32 detector and one '33 Pentode Audio—15 to 200 meters—four coils, supplied. The "EAGLE" is economical—two dry cells will operate the filaments. See March or April 1933 QST for full description of this most excellent value in short wave receivers.

"Eagle" completely wired and tested.. **\$11.95** Three tubes tested in your receiver.. **\$3.00**

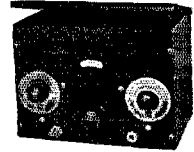

EXTRA SPECIAL

510-A tube Thoriated Tungsten Filament Graphite Plate—Isolantite Base, \$2.45

GROSS CASED CLASS "B" TRANSFORMERS

Heavy Duty — for use with 10's, 46's or 4-46's in push-pull par. per pr. ..\$7.50
For 2-46's only, per pr. 4.65

HOYT MOVING COIL METERS
0-1 MA 3" wide flange meters \$2.90

Filament Transformers shielded in metal cases, center tapped secondaries
2.5 Volt 10 amperes for 866's. \$2.25
10 to 12 Volts at 8 amperes. 2.25

Special 10-12 Volt 7.5 ampere filament transformer, extra special. \$1.10

Cased Combination Filament Transformer
2½ V.C.T., 10 amps for 866's
10 V.C.T., 7 amps for '50's or '52's
10000 volts insulation. \$3.24

THORDARSON TRANSFORMER
600 volts each side of C.T. 200 MA 2½ V.
10 amps. C.T., 5 V. 3 amps., 7½ V. 3
amps. C.T. \$3.39

Thord. Choke 12 H 250 MA. \$2.60
Thord. Choke 15 H 250 MA. \$2.95
Gross Cased Choke 30 H 125 MA. \$2.95
Gross Cased Choke 30 H 200 MA. \$1.94
Gross Cased Choke 20 H 350 MA. \$4.95

Hoyt Antenna Meter

Hot wire antenna meters, 2½" mounting hole, flange 3" diameter, supplied in 1½, 3 and 5 ampere ranges. Why work without antenna meters when you can buy them at this special price? \$2.95
See August QST for MA and volt meters

Universal Antenna Coupling System Inductances

Wound on threaded double X natural bakelite tubing, can easily be tapped, with clip supplied, ea. \$1.50
(Use one coil for single-wire feed and two coils for two-wire systems)

Low C 40-80-160 Meter Amplifier Coils
(See transmitter by GRAMMER page 46 May QST) Plug-in, wound on threaded natural bakelite tubing, will tune with 50 or 60 mmf. condenser any size, each. \$1.75

EXTRA SPECIAL

210 tube — Thoriated Tungsten Filament \$1.15

FILAMENT TRANSFORMER FOR BRIDGE RECTIFIER

For 866 tubes 2½ V.—2½ V.—2½ V.C.T.
10,000 volt insulation **\$4.50**

FILAMENT TRANSFORMER FOR BRIDGE RECTIFIER

using 83 tubes 5 v-5 v-5 at 3 amps
C.T.—3000 v insulation. \$2.25

GROSS CASED POWER TRANSFORMERS

650 v ea. side C.T. 350 ma fila. 2-7½ v C.T. and 1-5 v will give 500 v with choke input using 83 or 5Z3 tubes. You can run your entire R.F. and class B off this trans. \$5.50

750 v ea. side C.T. 300 ma fila. 2-7½ v C.T. and 1-5 v. \$5.75
750-1000 v ea. side of C.T. 300 watts, \$6.65

850-1350-1500 v ea. side of C.T. 400 watts \$8.70
(the ideal job to give 750-1000-1250 v D.C. with choke input)

850-1350-1500 v ea. side of C.T. 550 ma. \$12.50
1500-2000 v ea. side of C.T. 800 watts \$11.70

EXTRA SPECIAL MOUNTED UNCASED TRANSFORMERS

500-750-1000 volt each side of C.T. 300 watts. \$5.50
400-800 volts each side of C.T. 160 MA. \$3.40

Mounted Center Tapped Filament Transformers

2½ v 8 a — 2½ v 3 a — 5 v 3 a .. \$1.29
2½ v 4 a — 7½ v 2½ a — 7½ v 2½ a .. \$1.29

2½ v 4 a — 5 v 3 a — 7½ v 2½ a .. 1.29
5 v 3 a — 7½ v 2½ a — 7½ v 2½ a .. 1.29
2½ v 6 a — CT (midget)74
5 v 3 a — CT (midget)69
6.3 v 1.5 a — CT (midget)74
7½ v 3 a — CT (midget)89

RAYTHEON RK-20

The New RF Pentode Power Amplifier Tube in stock. \$15.00
(see page 14 June QST)

EXTRA SPECIAL

866 tube — Heavy Duty Rectifier — Isolantite Top \$1.45

HIGH QUALITY CASED COND.

2 mfd 2000 V. working. \$3.95
2 mfd 1000 V. working. 2.10

Hard Drawn Tinned Copper Antenna Wire
No. 12 (any length) per 100 ft. \$.55
No. 14 (any length) per 100 ft.35

SPECIAL TUBES !!

CARBON PLATE 203-A. \$8.75
CARBON PLATE 800. 4.90
888 or 871 Isolantite top.95
½ and 1 watt Neon Bulbs.29

Midget Double Spaced 50 mmf neut. cond. \$3.59
Midget Double Spaced 35 mmf neut. cond. \$4.49

GROSS TRANSMITTING R.F. CHOKES
4½ MH — D.C. Res. 12½ ohms current cap. 650 MA. Spec. \$7.79

JOHNSON new line of Transmitting Condensers — complete line in stock.

200 WATT VITREOUS RESISTORS With Variable Sliders

1000 ohms. \$.99
2500 ohms. 1.05
5000 ohms. 1.05
10000 ohms. 1.11
15000 ohms. 1.20
25000 ohms. 1.29
35000 ohms. 1.35
50000 ohms. 1.44
60000 ohms. 1.49
80000 ohms. 1.59
100000 ohms. 1.65

GROSS Crystal Holder

WHITE CERAMIC commercial type crystal holder — priced at less than ordinary holders. Adjustable pressure, dust proof, no tools required to open. Takes crystal to 1½" square. Plugs standard ¼" spacing. Most efficient job yet. \$1.00

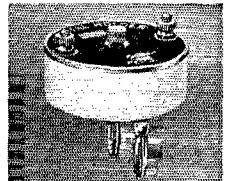

20% deposit with all C.O.D. orders. Remit by M.O. Include postage

GROSS RADIO, INC., 51 VESEY STREET, NEW YORK CITY

Say You Saw It in QST — It Identifies You and Helps QST

Another New Outstanding Gross Value

GROSS CB-100

Is a 100-Watt Radiophone and C.W. transmitter completely housed in an entirely enclosed floor rack of ingenious design. All units are fully accessible through the removable front gates, for coil changing antenna network adjustments, etc. Incorporates everything from microphone jack to impedance matching antenna network.

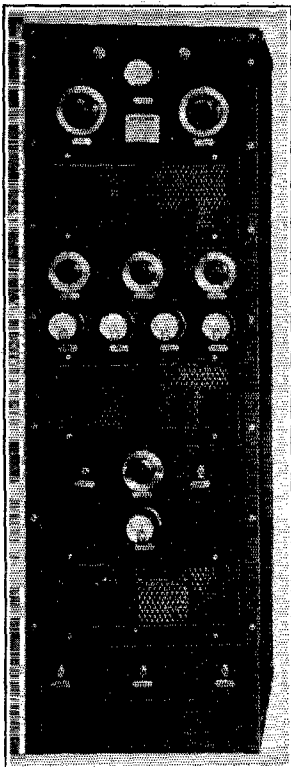

- **R. F. LINE UP**
47 crystal oscillator, two 46's buffer, 03-A amplifier.
- **FREQUENCY COVERAGE**
1.7, 3.5, 7 and 14 MC Bands.
- **POWER SUPPLIES**
1050 and 1200 volts at 400 MA choke input, 8 mfd Pyronal condenser used and 400 volts at 300 MA.
- **SPEECH AMPLIFIER**
Special four stage high gain speech amplifier self contained from microphone jack to gain control.
- **MODULATOR**
Two 800's are used in the Class B Modulator. 100% modulation.
- **ANTENNA UNIT**
Impedance matching network supplied for use with any type of antenna available.
- **OPERATING CONTROLS**
Terminations provided for operating all switches from operating table.
- **SIZE**
60" high, 19½" wide, 16" deep.



Rear view with back enclosure removed

Descriptive Literature Sent Upon Request

HONEST RATINGS VERSUS EXAGGERATED CLAIMS

It has come to our attention that a number of so-called 100-watt phone transmitters which are not honestly rated are being marketed.

One or two 50-watt pentodes, suppressor-modulated, will give rated outputs of 15 and 30 watts respectively. (See articles on this type of transmitter in previous issues of *QST*.) The CB-100 (nominal rating 100 watts) has an average measured output of 130 watts; the same as other legitimately-rated transmitters employing an 03-A in the output stage.

GROSS RADIO, INC., 51 VESEY ST., NEW YORK Cable Address
GROSSINC

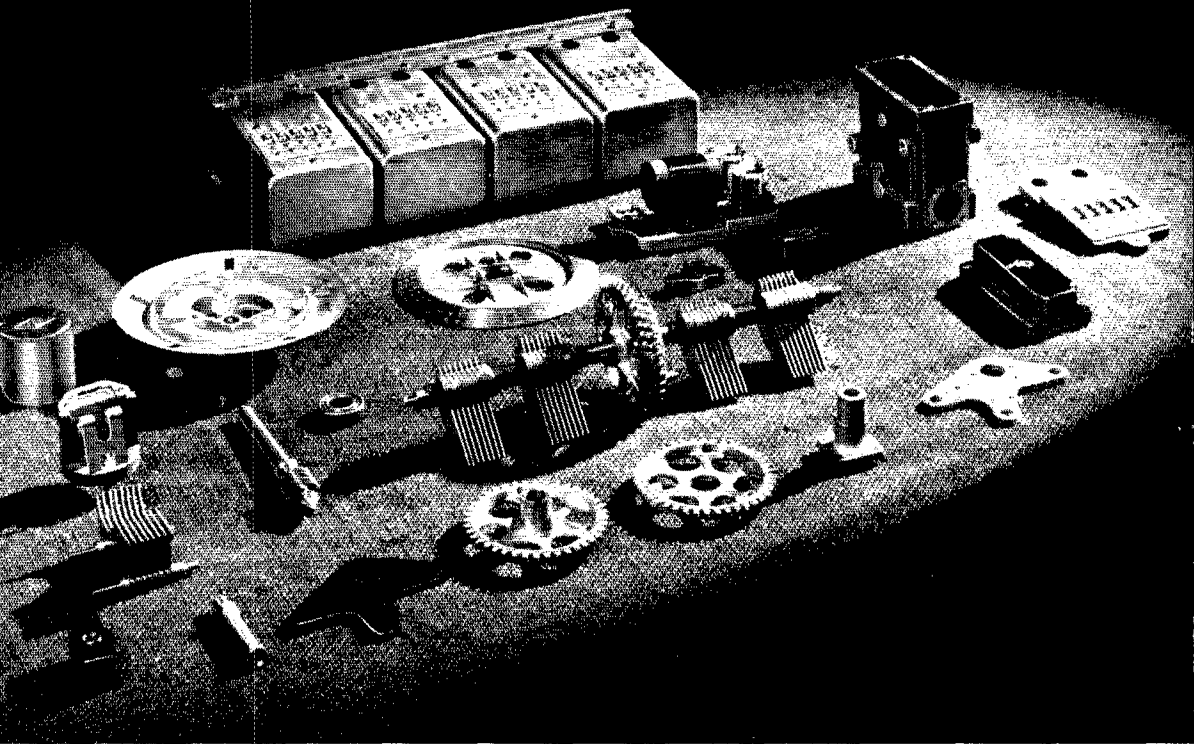

CONSIDER the parts illustrated above. Like the HRO from which they came, they demonstrate more clearly than any words the thorough engineering that distinguishes every National design. In painstaking attention to detail, in accuracy and finish, and in the wealth of experience which guided their design, each part reveals its fitness for its own particular task. Perhaps they are really much finer than they need to be. Yet, when you first tune your HRO, you will find a little more responsiveness, a little extra smoothness, an ability in reserve. You will find it all you have come to expect of a National receiver.

NATIONAL



COMPANY

THE TREND IS UPWARD

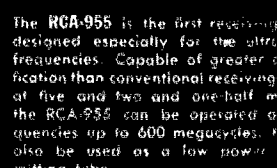

The RCA-955 is the first receiving tube designed especially for the ultra-high frequencies. Capable of greater definition than conventional receiving tubes at five and two and one-half meters, the RCA-955 can be operated at frequencies up to 600 megacycles. It also can be used as a low power transmitting tube.

Amateur's Net Price—\$10.00

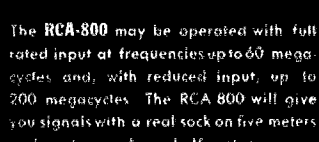

The RCA-800 may be operated with full rated input at frequencies up to 60 megacycles and, with reduced input, up to 200 megacycles. The RCA 800 will give you signals with a real sock on five meters and on two and one-half meters.

Amateur's Net Price—\$10.00

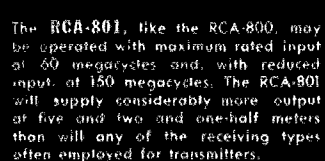

The RCA-801, like the RCA-800, may be operated with maximum rated input at 60 megacycles and, with reduced input, at 150 megacycles. The RCA-801 will supply considerably more output at five and two and one-half meters than will any of the receiving types often employed for transmitters.

Amateur's Net Price—\$5.75

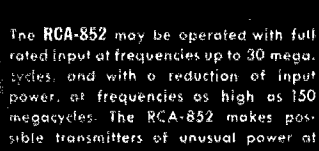

The RCA-852 may be operated with full rated input at frequencies up to 30 megacycles, and with a reduction of input power, at frequencies as high as 150 megacycles. The RCA-852 makes possible transmitters of unusual power at high frequencies.

Amateur's Net Price—\$23.80

The trend in amateur interests is toward the ultra-high-frequencies. More and more amateurs are devoting at least part

of their time to the fascinating subject of ultra-high-frequency experiments. Whether you are an old-timer on five meters, or a newcomer to the ultra-high-frequency bands, you will need some of the RCA types shown above—designed especially for the ultra-high-frequencies.

For information on these or any other RCA tubes, see your RCA deForest Distributor, or write to: